

# Analysis of Hydrogen and Competing Technologies for Utility-Scale Energy Storage



**HTAC Meeting  
Arlington, Virginia  
February 11, 2010**

**Darlene M. Steward  
NREL**

**NREL/PR-560-47547**

# Project Overview

---

## Presentation based on:

Lifecycle Cost Analysis of Hydrogen Versus Other Technologies for Electrical Energy Storage

D. Steward, G. Saur, M. Penev, and T. Ramsden  
National Renewable Energy Laboratory, Golden, CO  
NREL/TP-560-46719  
November 2009

## Collaborations and Reviewers

- NREL Hydrogen Technologies & Systems Center
- NREL Strategic Energy Analysis Center
- NREL Systems Engineering & Program Integration Office
- Pacific Northwest National Laboratory
- Xcel Energy & the Hydrogen Utility Group

# Outline

---

Energy Storage Scenario and Analysis Framework

Technologies

Analysis Results

Conclusions

# The Potential Value of Energy Storage

Make variable and unpredictable renewable resources dispatchable by:

- Reducing transmission costs for remote wind resources
- Taking advantage of arbitrage opportunities
- Allowing “baseloading” with renewable resources
- Providing grid services such as spinning reserve

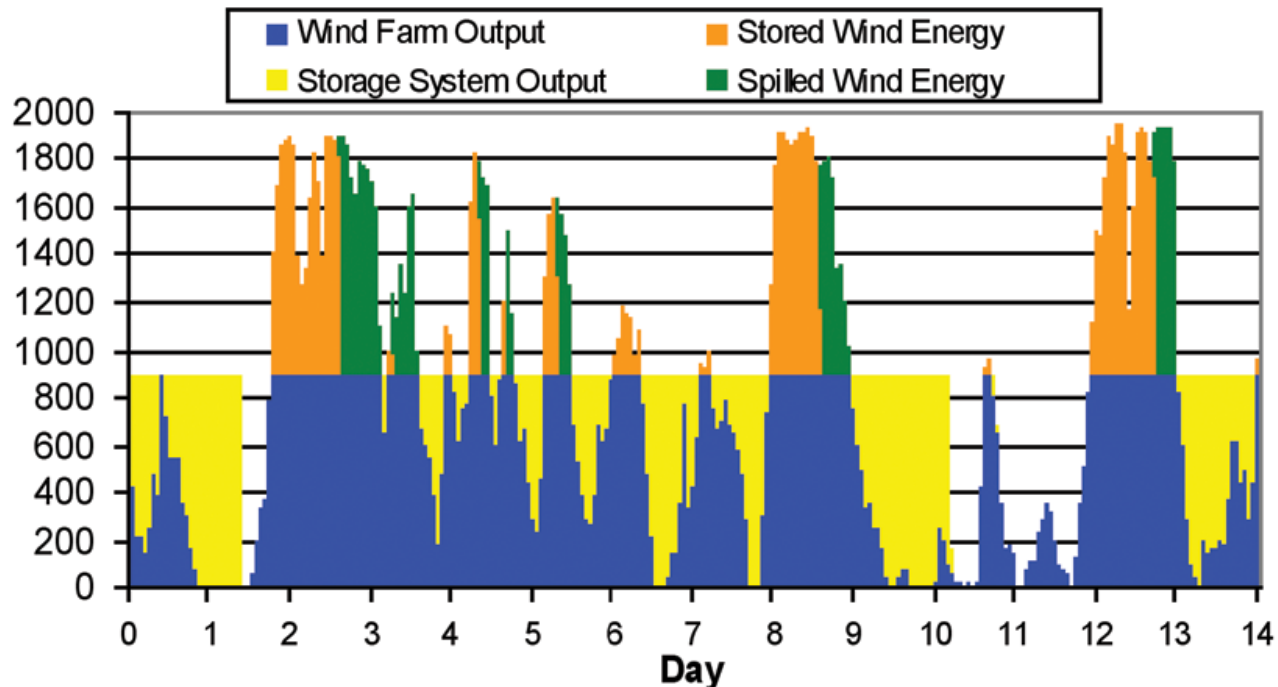

Source: Denholm, Paul. (October 2006). “Creating Baseload Wind Power Systems Using Advanced Compressed Air Energy Storage Concepts.” Poster presented at the University of Colorado Energy Initiative/NREL Symposium. <http://www.nrel.gov/docs/fy07osti/40674.pdf>

# Energy Arbitrage—The Focus of This Analysis

## Objective

Evaluate the economic viability of using hydrogen for utility-scale energy storage applications in comparison with other electricity storage technologies

## Study Framework

Basic energy arbitrage economic analysis

- Lifecycle costs including initial investment, operating costs, and future replacement costs
- Results presented as levelized cost of delivered energy (\$/kWh)

Benchmark against competing technologies on an “apples to apples” basis

- Batteries
- Pumped hydro
- Compressed air energy storage

# Energy Storage Scenario

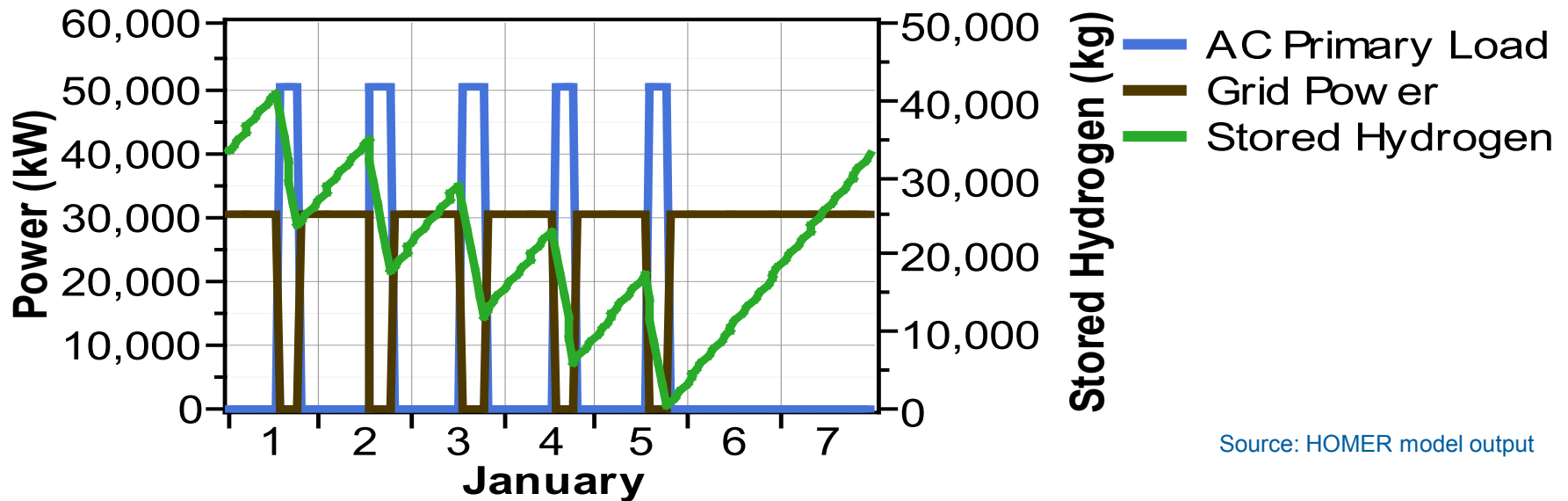

Source: HOMER model output

Nominal storage volume is 300 MWh (50 MW, 6 hours)

- Electricity is produced from the storage system during 6 peak hours (1 to 7 pm) on weekdays
- Electricity is purchased during off-peak hours to charge the system

Electricity source: excess wind/off-peak grid electricity

- Assumed steady and unlimited supply during off-peak hours (18 hours on weekdays and 24 hours on weekends)
- Assumed fixed purchase price of off-peak/renewable electricity

# Analysis Framework and Assumptions

## Major Assumptions

- The storage system is not large enough to affect grid peak or off-peak electricity prices
- No taxes or transmission charges are included in the analysis
- The supply of off-peak and/or renewable electricity is unlimited
- Costs are presented in \$2008

## Timeframes

- High cost or “current” technology
- Mid-range cost
  - Some installations exist
  - Some cost reductions for bulk manufacturing and system integration have been realized
  - Installations are assumed in the near future: 3 to 5 years
- Low-range cost
  - Estimates for fully mature technologies and facility experience

## Cost Analysis Performed Using the HOMER Model (HOMER Energy,

www.homerenergy.com)

- Distributed power cost optimization model for conventional and renewable energy technologies
- Results are presented as levelized cost of energy: \$/kWh or \$/kg for hydrogen

# Study Framework—Facility Life Economic Analysis

## Financial Assumptions

- 40-year plant life (Some equipment will be replaced at more frequent intervals.)
- 10% after-tax internal rate of return
- 100% equity financing

## Cost Assumptions

- Electricity is purchased from the grid during off-peak hours at 3.8¢/kWh (base case); sensitivity cases at 2.5¢/kWh and 6¢/kWh
- Natural gas is purchased at \$7/mmBtu (base case); sensitivity cases at \$5/mmBtu and \$9/mmBtu for the CAES system



# Hydrogen for Energy Storage

## Concept:

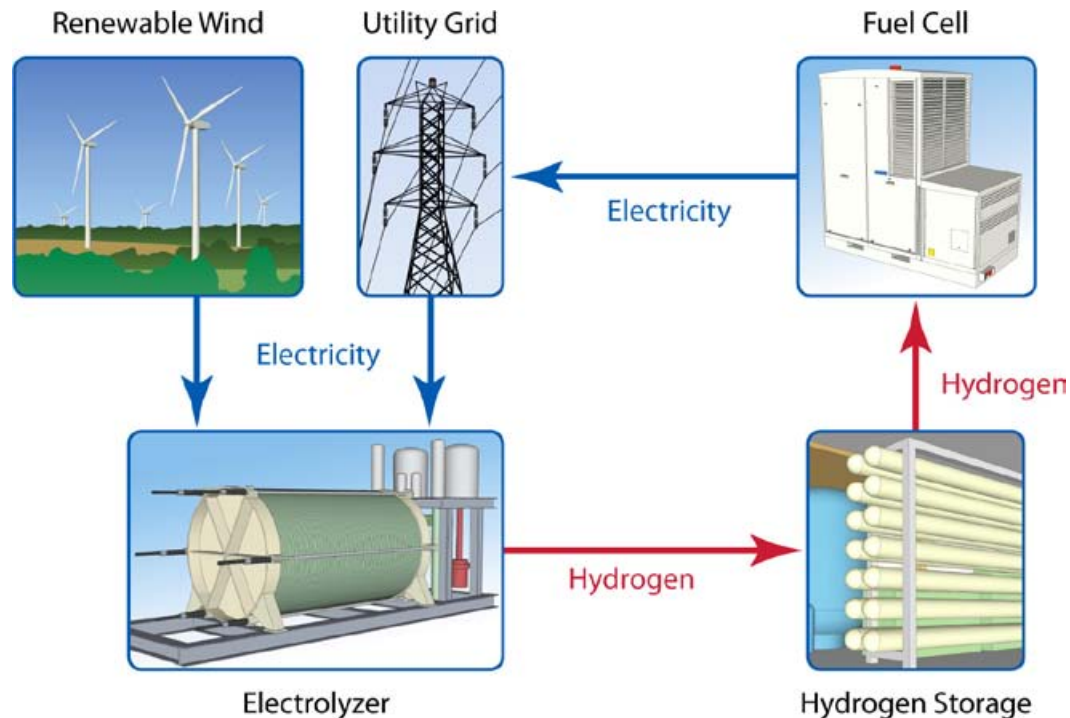

Two scenarios of production of excess hydrogen for vehicle use:

- “Slipstream” of about 1,400 kg additional hydrogen per day from aboveground storage tanks (5 tanker trucks per day)
- 500 kg/h (12,000 kg/day) additional hydrogen continuously fed to a pipeline

Electrolyzer is only run during off-peak hours.

# Hydrogen Scenarios—Major Assumptions

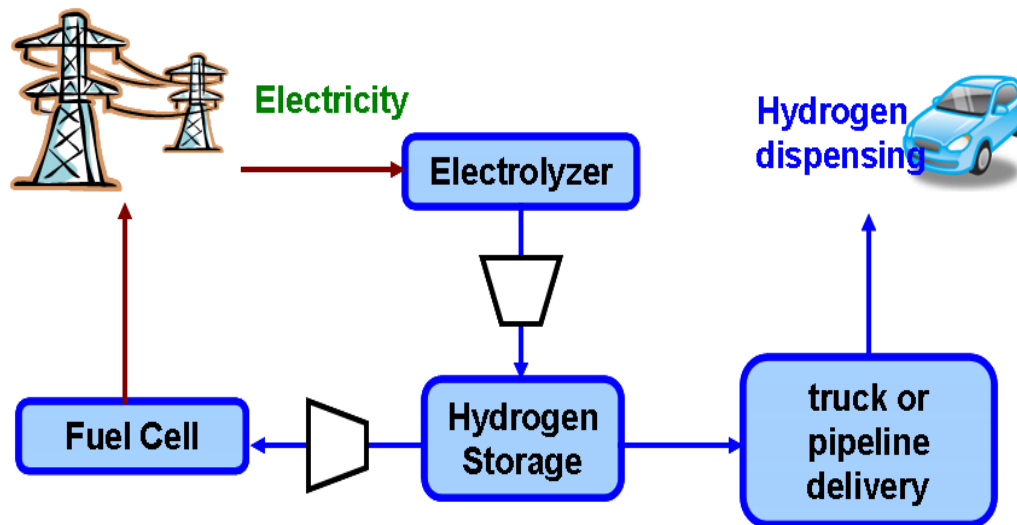
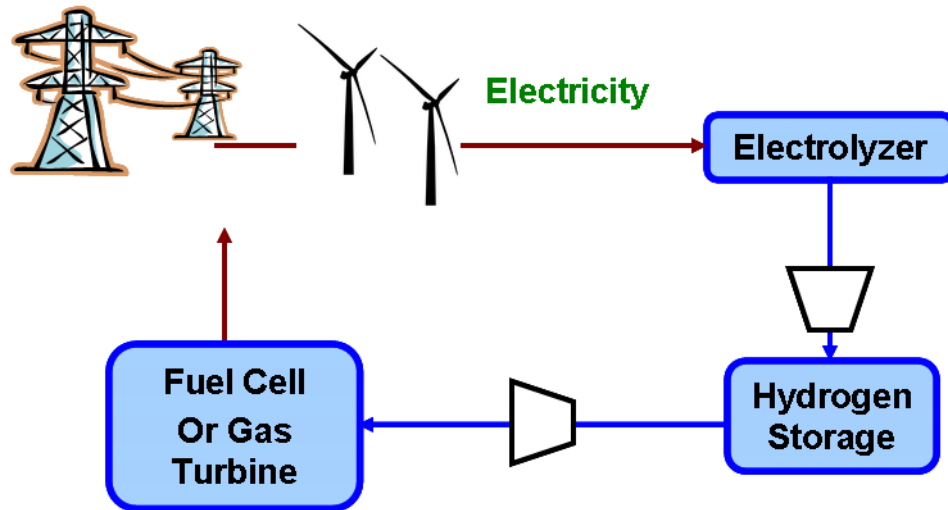

## Major Assumptions

- Electrolyzer performance and cost based on alkaline electrolyzers operated at 435 psi, 80°C
- Polymer electrolyte membrane (PEM) air cooled fuel cell operated at ~ 30 psi
- Hydrogen storage in aboveground steel tanks or geologic storage
  - Hydrogen storage losses assumed minimal
  - Compression energy not recovered
- Hydrogen delivery and dispensing not included in the analysis of excess hydrogen for vehicles

# Batteries, Pumped Hydro, & CAES—Major Assumptions

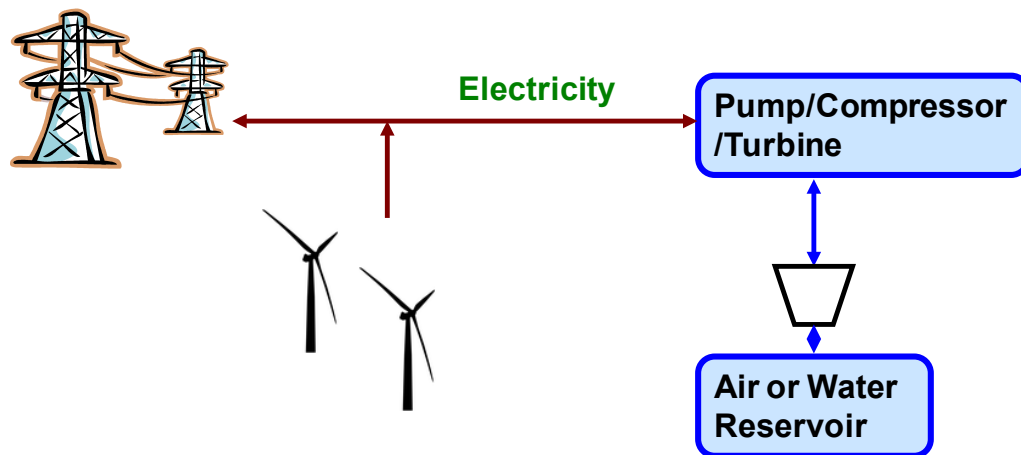
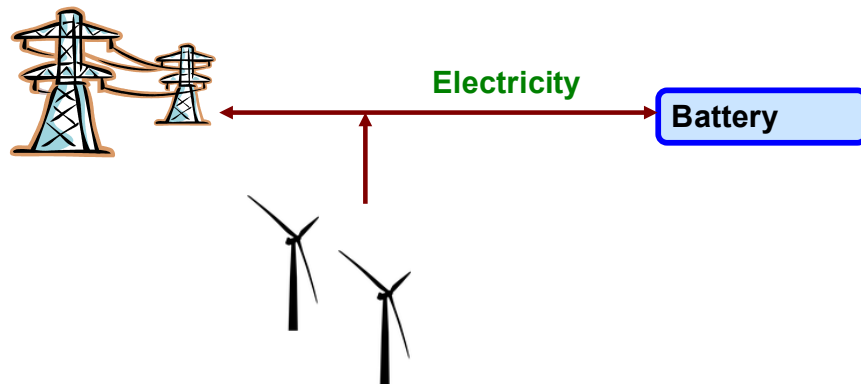

## Major Assumptions

- Power conversion system for battery round-trip efficiency is 90%.
- Pumped hydro and CAES systems do not require separate power conversion system.
- For compressed air storage systems, compression heat is not stored. Air from the storage system is heated with turbine exhaust gas.

# Levelized Cost Comparison of Hydrogen and Competing Technologies

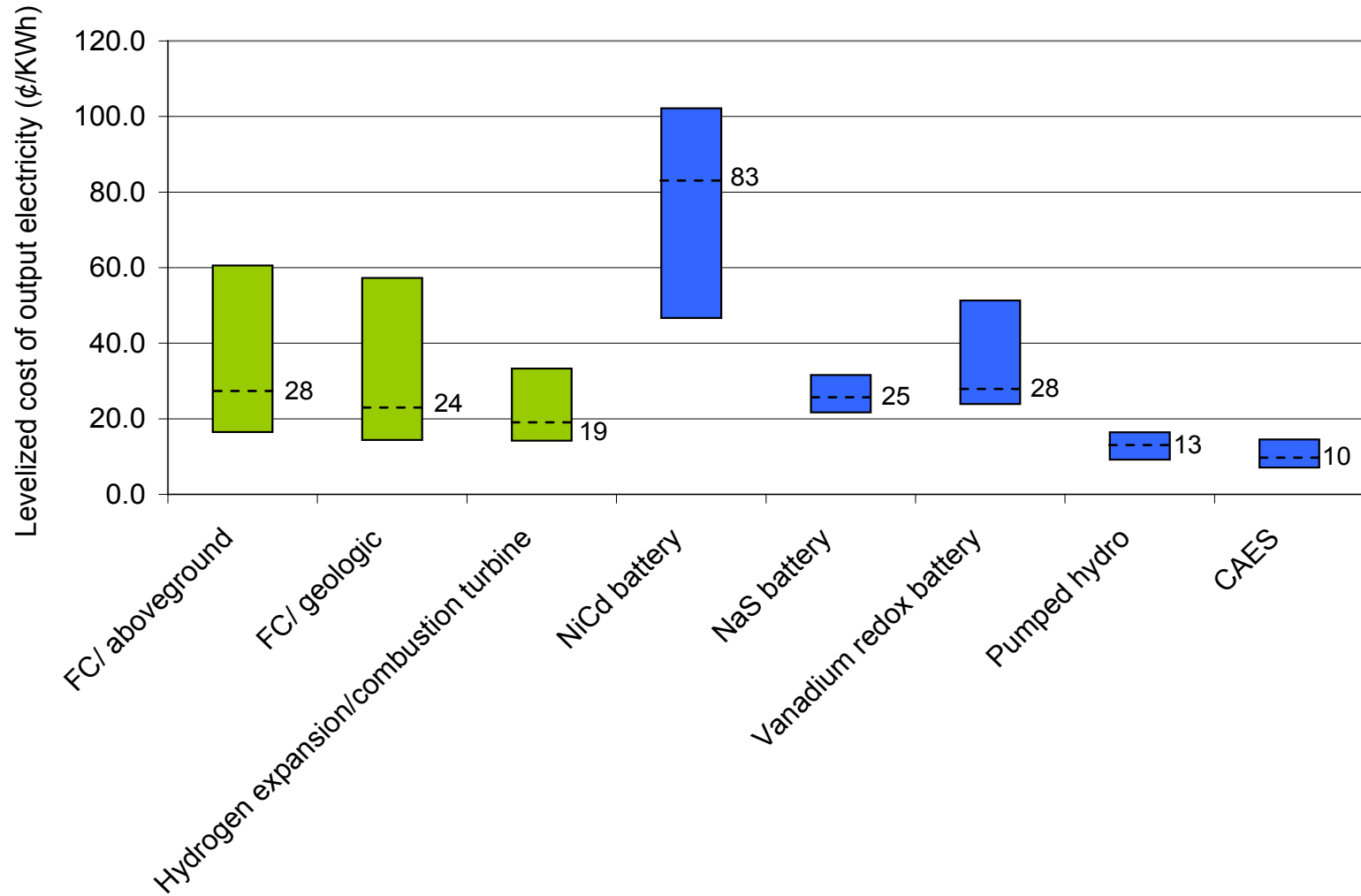

Hydrogen is competitive with batteries and could be competitive with CAES and pumped hydro in locations that are not favorable for these technologies.

# Hydrogen Energy Storage System with Excess Hydrogen—NPC

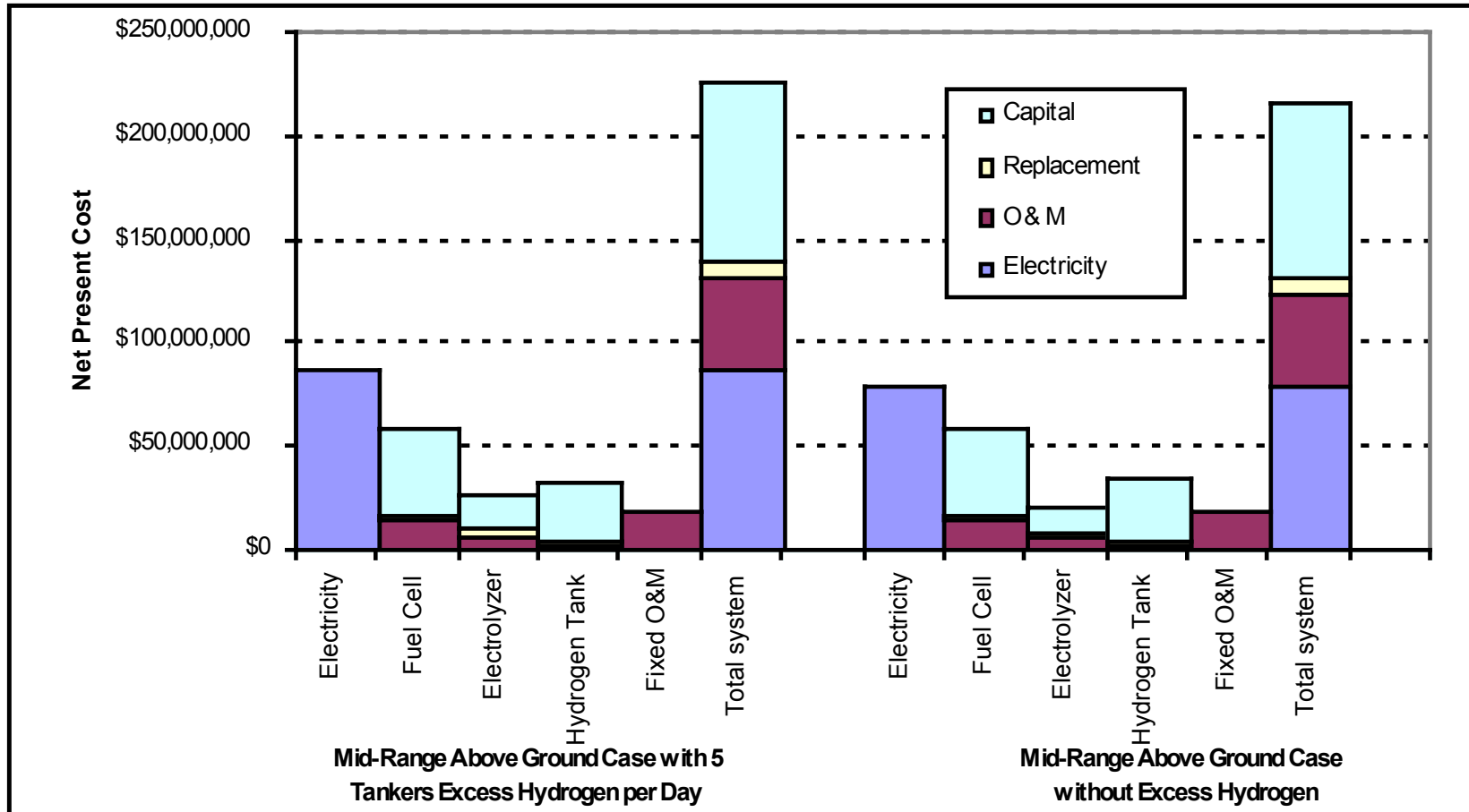

## Five tankers of excess hydrogen per day (1,400 kg/day)

- Electrolyzer and hydrogen tank slightly larger for the excess hydrogen case than for the case without excess hydrogen
- Hydrogen LCOE of \$4.69/kg (not including tanker truck transport and dispensing)
- Compares to ~\$4 for production portion of electrolysis forecourt station

# Hydrogen Energy Storage System with Excess Hydrogen—NPC

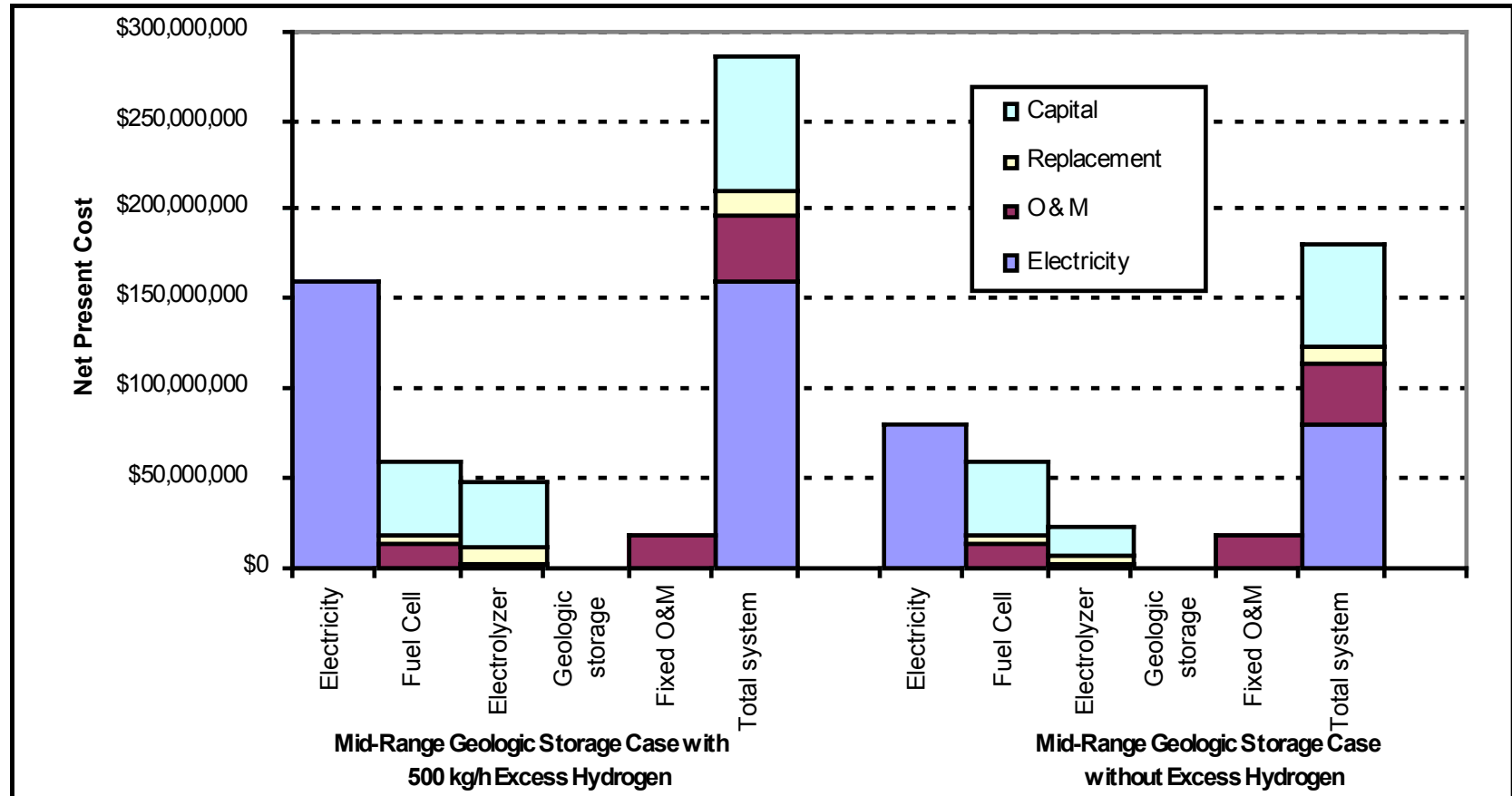

## 500 kg/h of excess hydrogen (12,000 kg/day)

- Electrolyzer approximately doubled in size in comparison to the case without excess hydrogen
- Hydrogen LCOE of \$3.33/kg (not including tanker truck transport and dispensing)
- Compares to ~\$7 for electrolysis at a central production facility of the same size

# Hydrogen Systems Cost Analysis

**Electrolyzers and Storage**—Cost values and projections based on H2A case studies and DOE technical and cost targets

**PEM Fuel Cell**—Cost values and projections based on literature review and DOE technical and cost targets

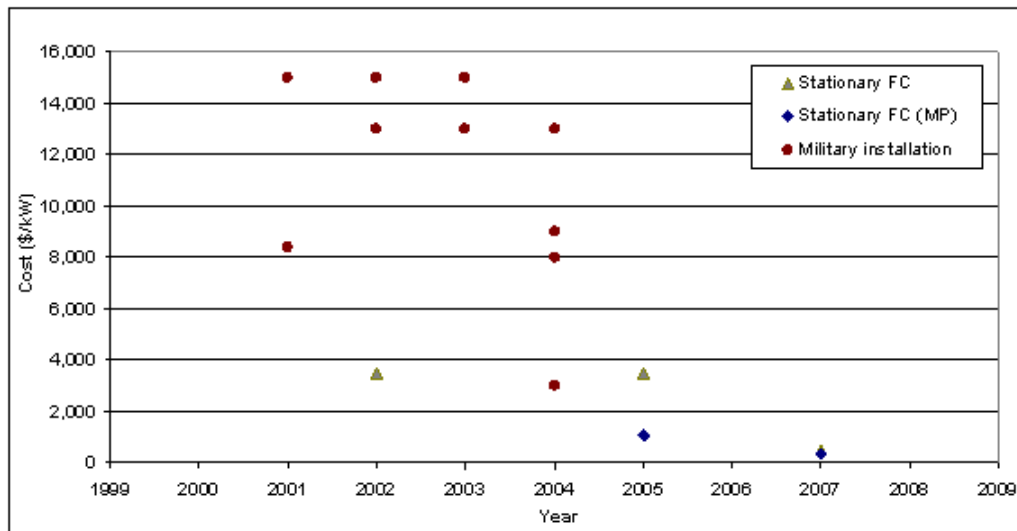

Existing PEM fuel cell costs and estimates for mass production (MP) of PEM fuel cells

**Hydrogen Fueled Gas Turbine**—Cost and performance values and projections based on literature review

- High-efficiency gas turbine combusts pure oxygen and hydrogen in a combustion chamber to produce high-temperature steam, which drives a steam turbine. Efficiency = 70% (Pilavachi et al. 2009)
- Oxygen is assumed to be collected from the electrolyzer.

# Battery Cost Analysis

## Batteries

### Nickel Cadmium

- 2003 peak power in Fairbanks Alaska (26 MW, 1/2h)

### Sodium Sulfur

- Several projects for Tokyo Electric Power (up to 6 MW, 48 MWh)

### Vanadium Redox

- 2005 peak power in Hokkaido Japan (4 MW, 1.5h)
- 2004 voltage-stabilization project in Castle Valley Utah (250 kW, 8h)
- 2003 load-shifting application in Currie Tasmania (200 kW, 4h)
- 2001 wind stabilization in Hokkaido Japan (170 kW, 6h)

Sources: Schoenung and Eyer (2008), EPRI (2007), Nakhamkin et al. (2007), Electricity Storage Association (2009)



# Compressed Air & Pumped Hydro Cost Analysis

## Compressed Air Energy Storage

- 1991 peak power in McIntosh Alabama (110 MW, 26h)
- 1978 Huntorf Germany (290 MW spinning reserve)

## Pumped Hydro

- Many installations, earliest in the U.S. in 1929; current capacity about 19,000 MW

Sources: Schoenung and Eyer(2008), EPRI (2007), Nakhamkin et al. (2007), Electricity Storage Association (2009)

# Round-Trip Efficiency and Electricity Price Sensitivity

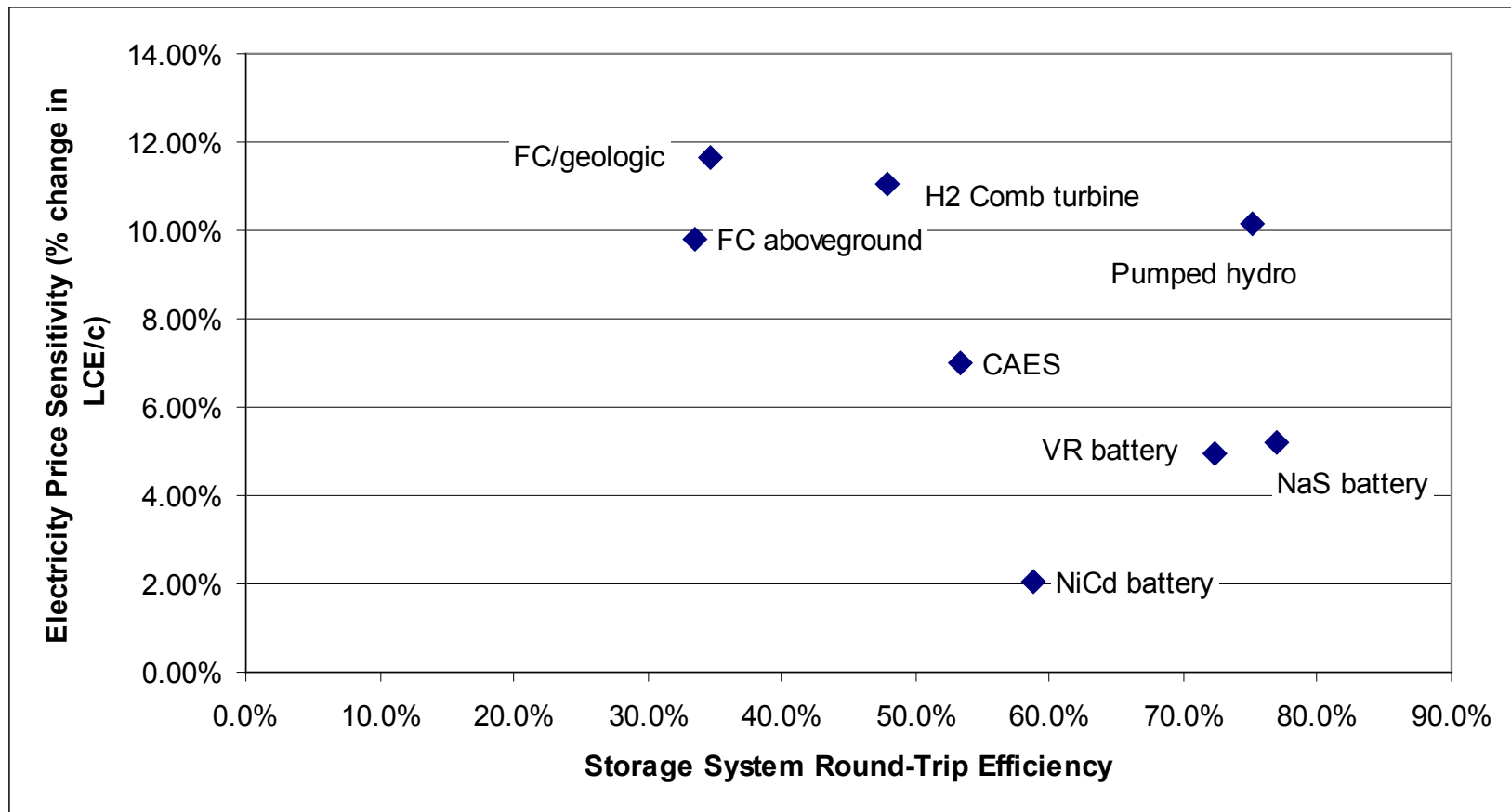

## Electricity price sensitivity

- Low-capital-cost, high-efficiency pumped hydro system is sensitive to electricity price
- High-capital-cost NiCd system is insensitive to electricity price
- For other storage systems, sensitivity to electricity price is roughly inversely proportional to round-trip efficiency

# Cost Implications for Hydrogen Systems

---

Costs could be reduced by increasing the round-trip efficiency.

- Fuel cell efficiency has a bigger impact on LCOE than electrolyzer efficiency.
  - ~ 0.5% change in LCOE per percent change in fuel cell efficiency
  - ~ 0.2% change in LCOE per percent change in electrolyzer efficiency

Cost could be reduced if a reversible fuel cell with higher round-trip efficiency were developed.

# Conclusions

---

Hydrogen is competitive with battery technologies for this application and could be competitive with CAES and pumped hydro in locations that are not favorable for these technologies

Excess hydrogen could be produced for the transportation market.

Hydrogen has several important advantages over competing technologies, including:

- Hydrogen has very high storage energy density (170 kWh/m<sup>3</sup> vs. 2.4 for CAES and 0.7 for pumped hydro).
  - Allows for potential economic viability of aboveground storage
- Hydrogen could be co-fired in a combustion turbine with natural gas to provide additional flexibility for the storage system.

The major disadvantage of hydrogen energy storage is cost.

- Research and deployment of electrolyzers and fuel cells may reduce cost significantly.

---

**Thank You**

Questions?

# Hydrogen Fuel Cell with Geologic Storage—NPC

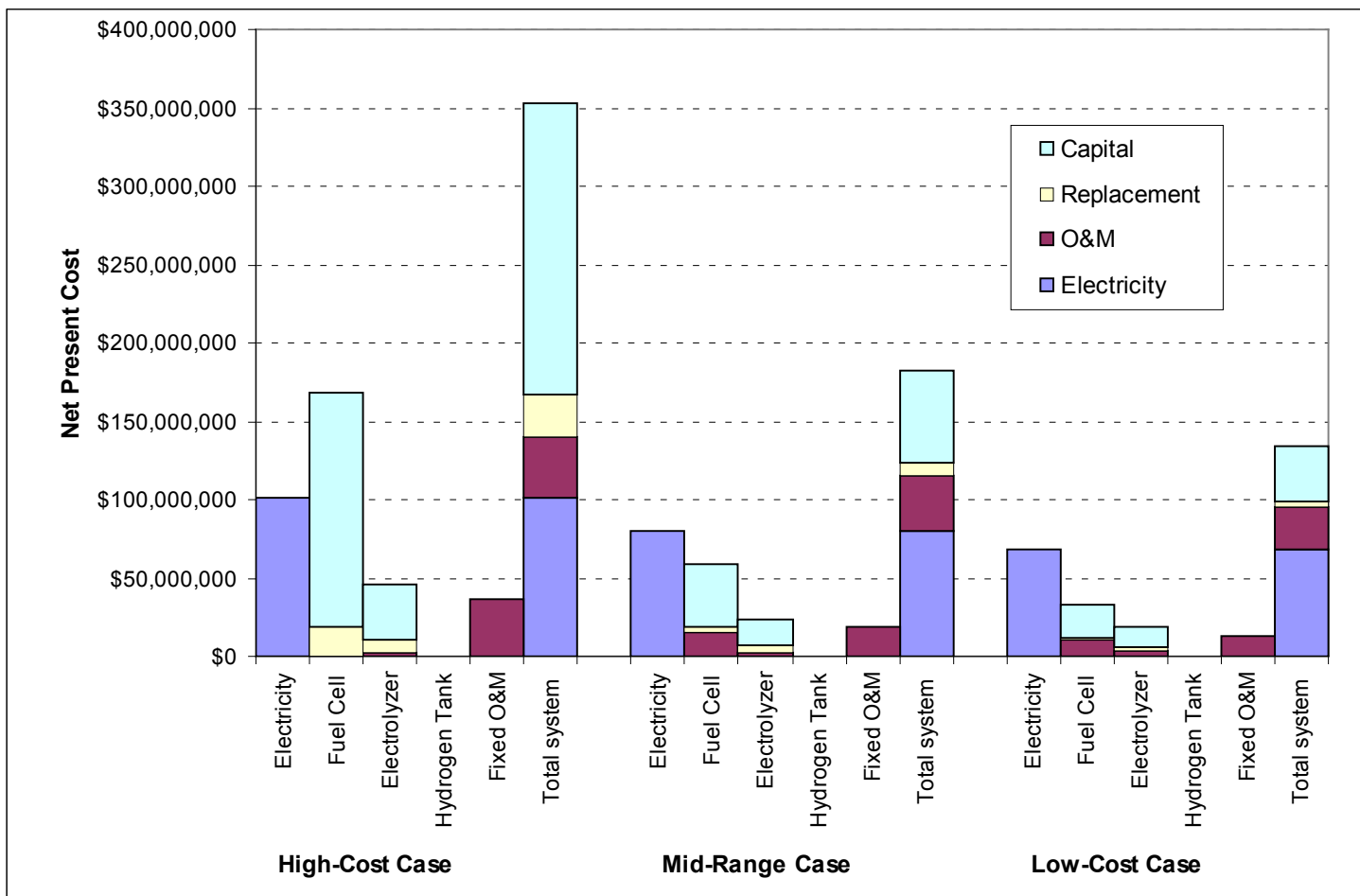

Capital cost reductions for the fuel cell drive decrease in NPC.

Increased stack durability decreases expected replacement costs.

# Hydrogen Fuel Cell with Geologic Storage—Sensitivity

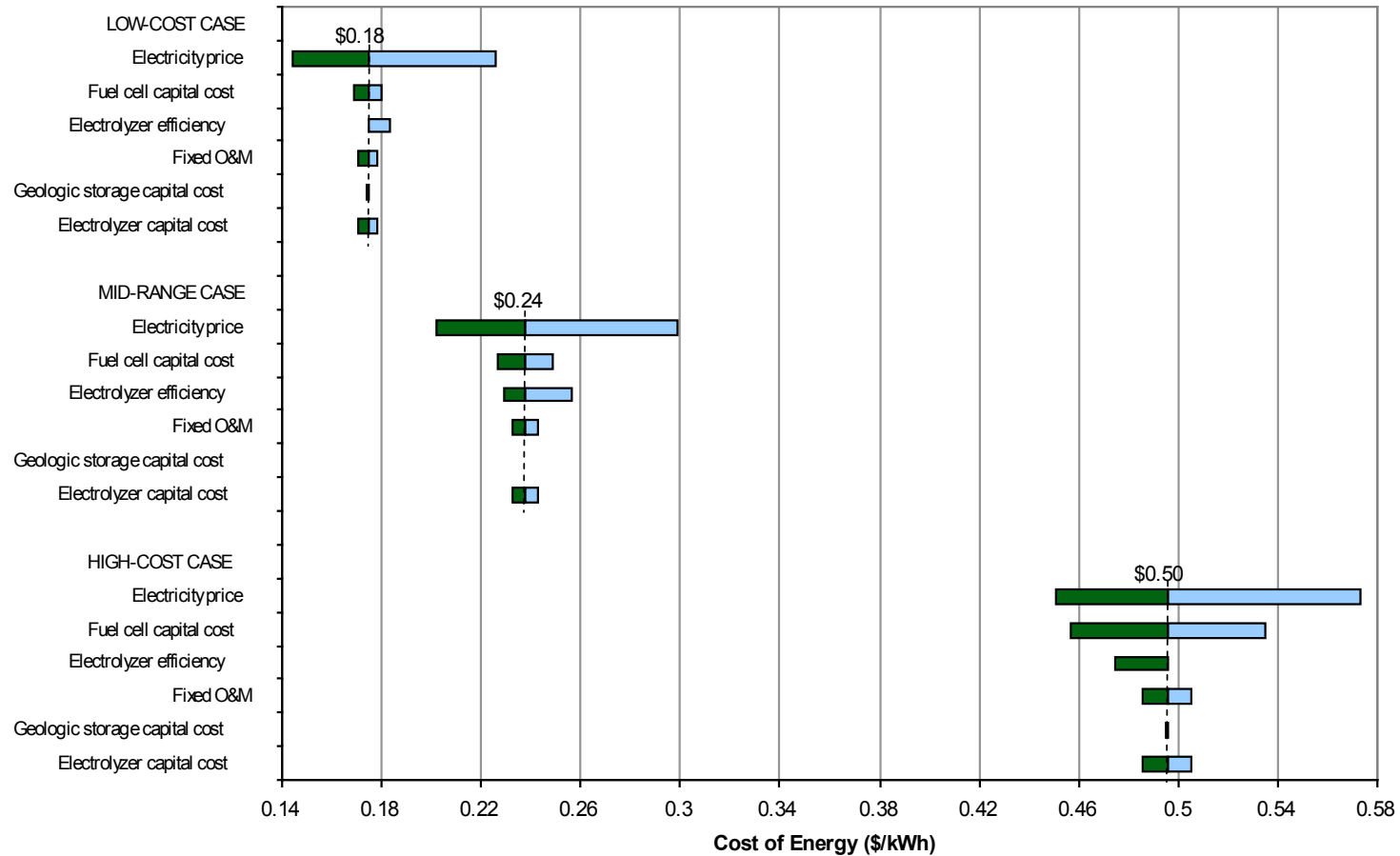

LCOE sensitivity to capital cost in proportion to other costs decreases from the high-cost case to the low-cost case.

High sensitivity to the cost of electricity due to relatively low round-trip efficiency (28% – 41%)

# Hydrogen Fuel Cell with Aboveground Storage—Sensitivity

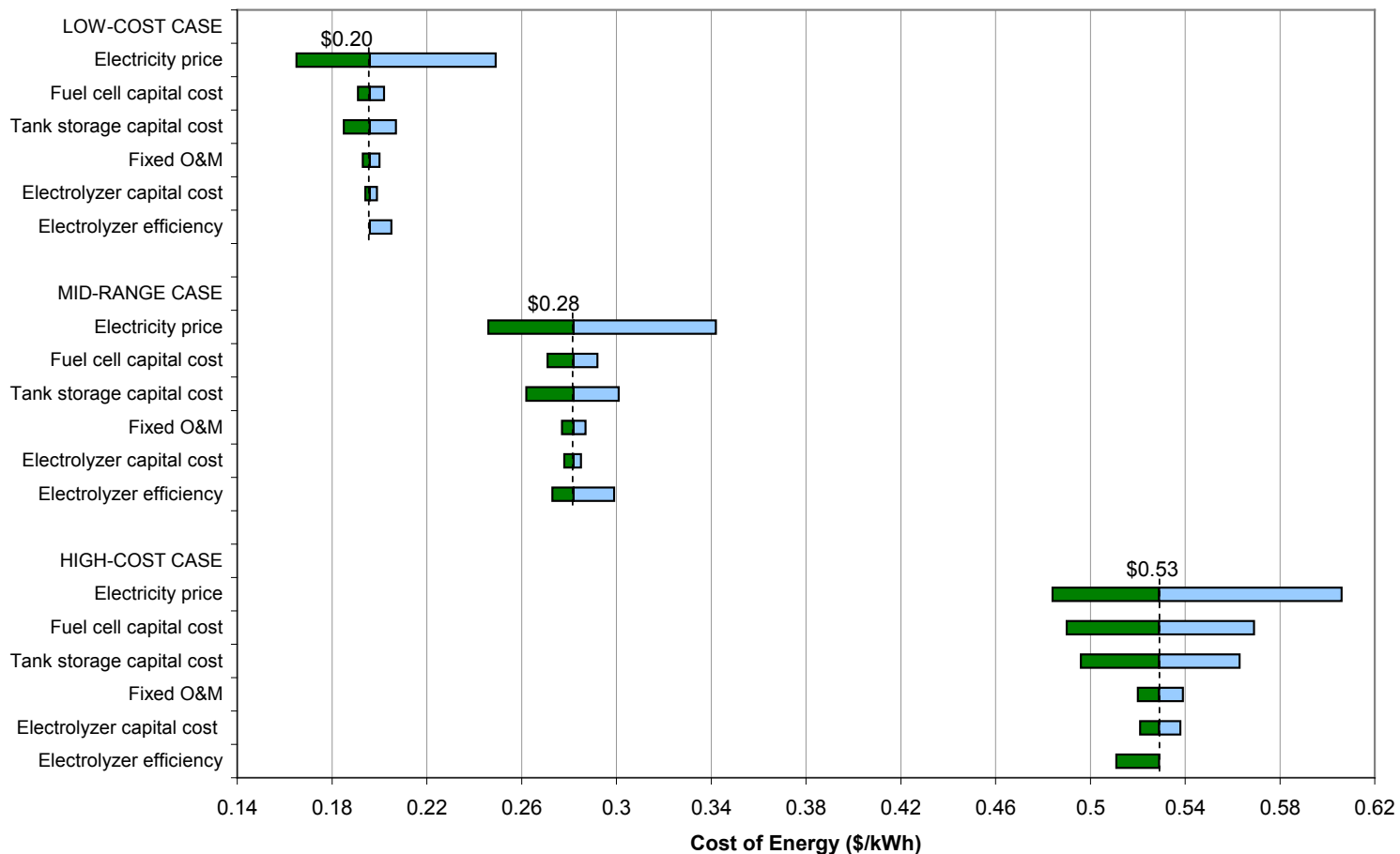

More tanks are required for the high-cost case because of the low efficiency of the fuel cell.

Aboveground storage adds 6% – 18% to the LCOE.



# Hydrogen Gas Turbine with Geologic Storage—Sensitivity

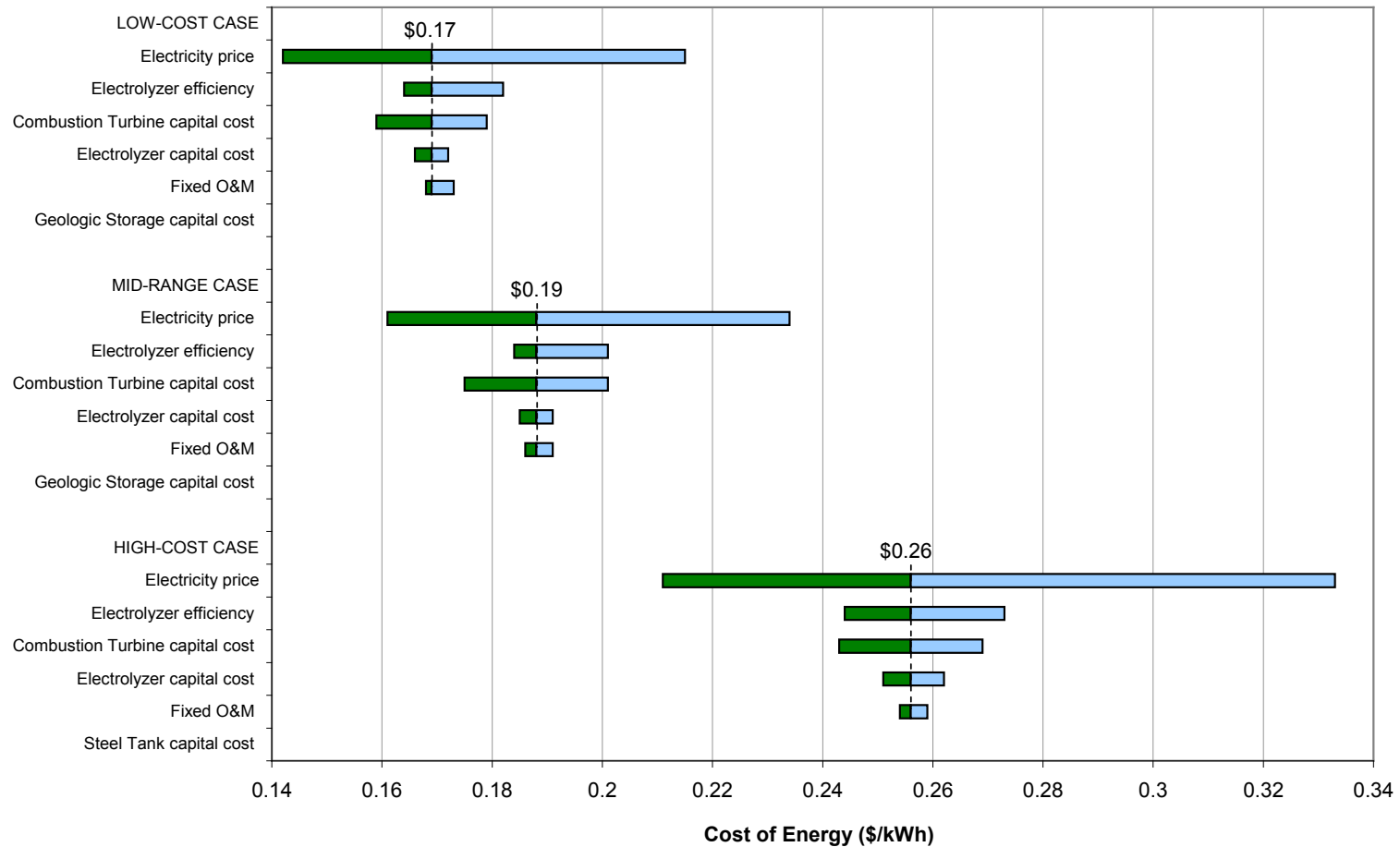

Hydrogen gas turbine with geologic storage is proportionally more sensitive to electricity cost because of its relatively low capital cost and low round-trip efficiency.

# Net Present Cost of Nickel Cadmium Batteries

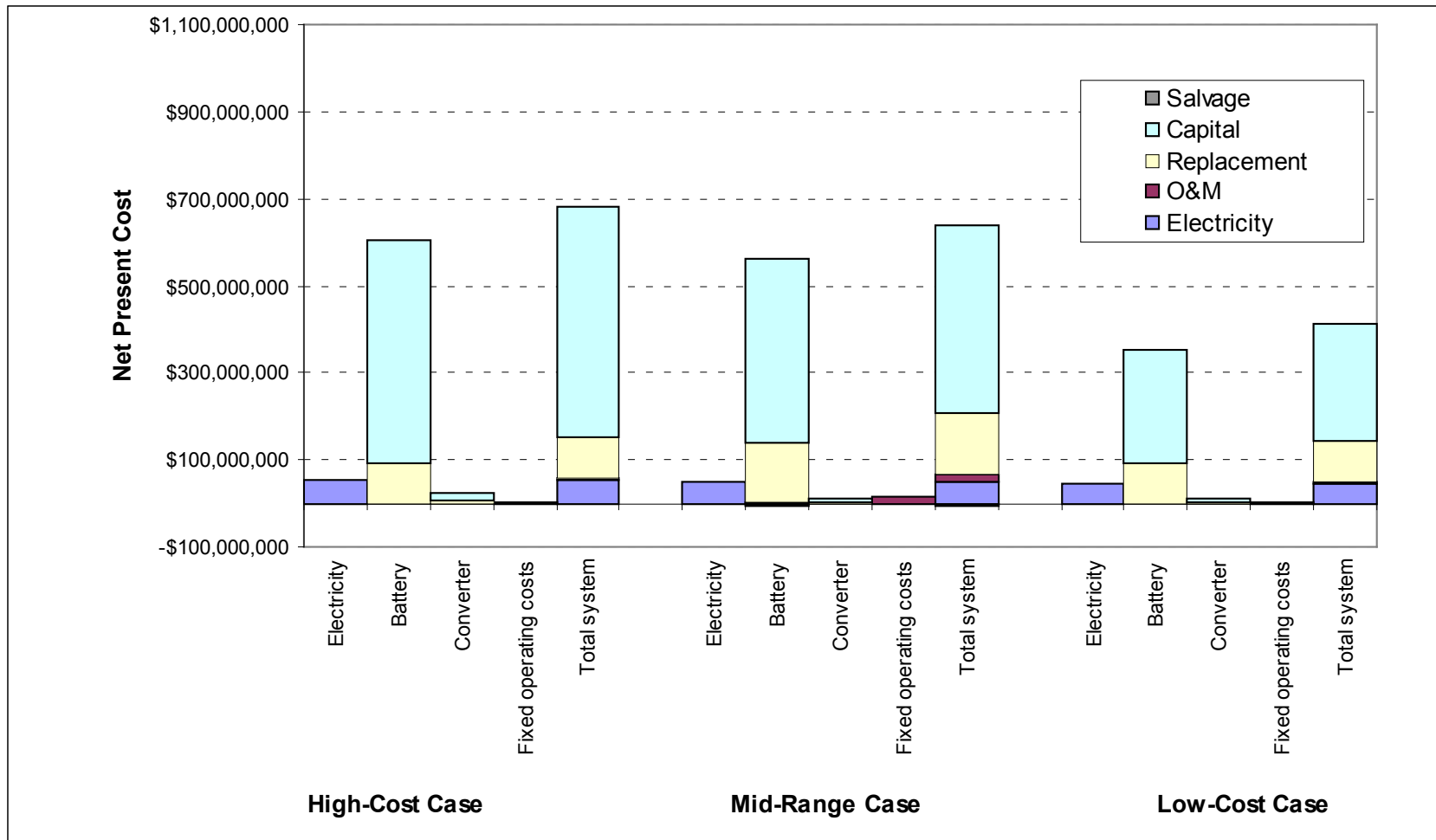

NPC for nickel cadmium battery systems is high due to high capital cost.

# NiCd Batteries—Sensitivity

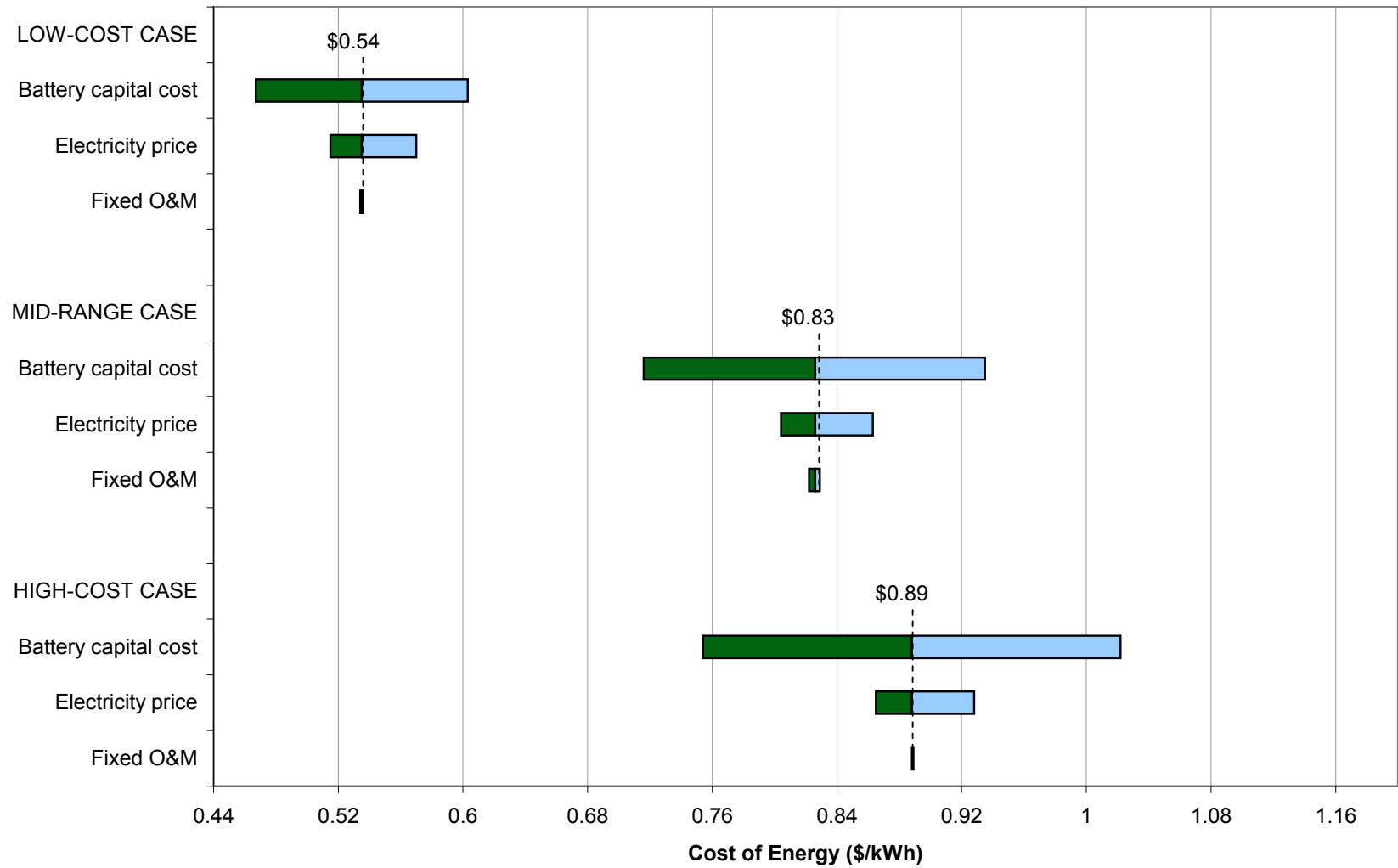

The LCOE of Nickel cadmium battery systems is most sensitive to capital cost.

# Net Present Cost of Sodium Sulfur Batteries

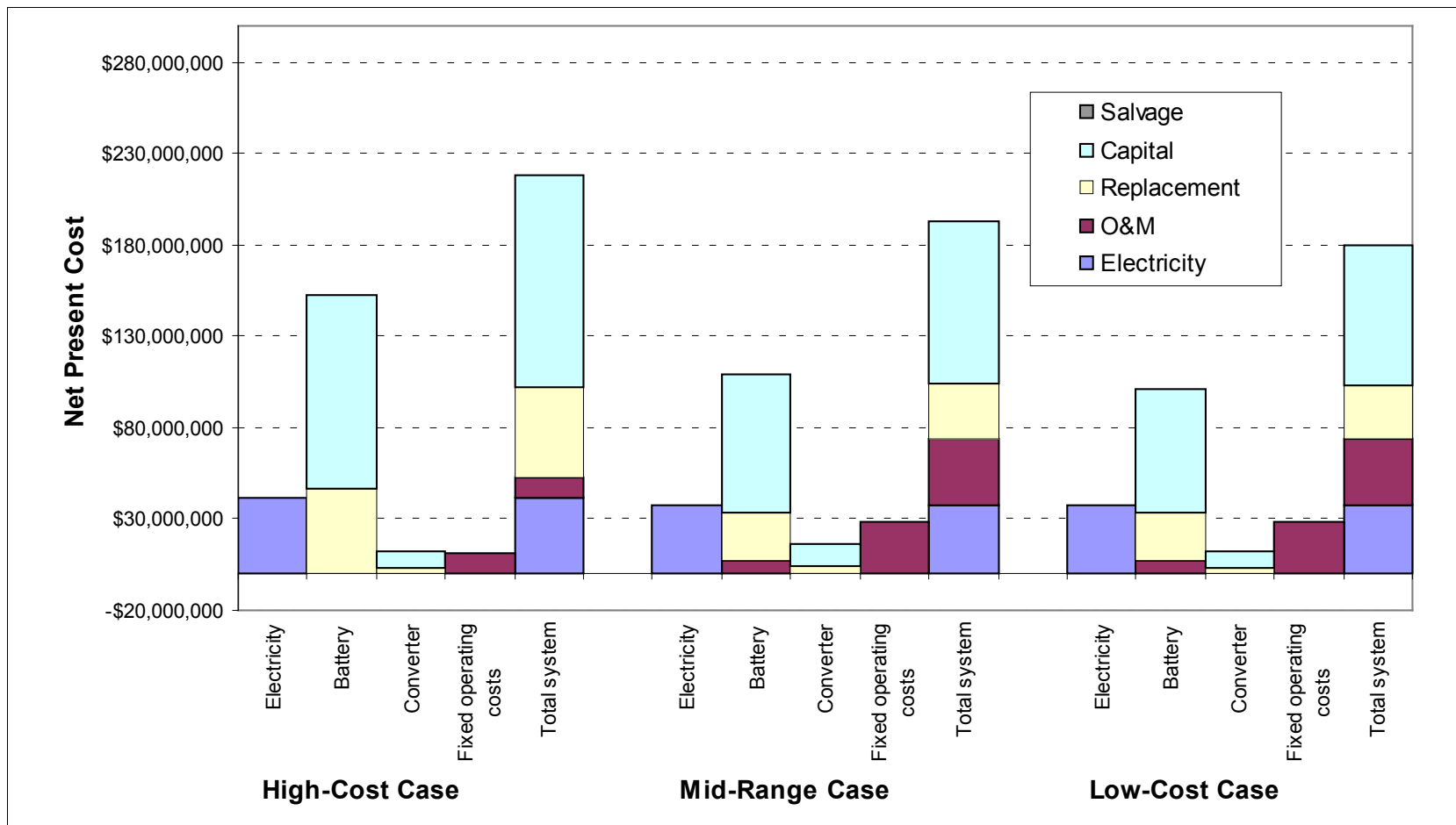

Sodium sulfur battery systems have lower capital and replacement costs than NiCd batteries.

# NaS Batteries—Sensitivity

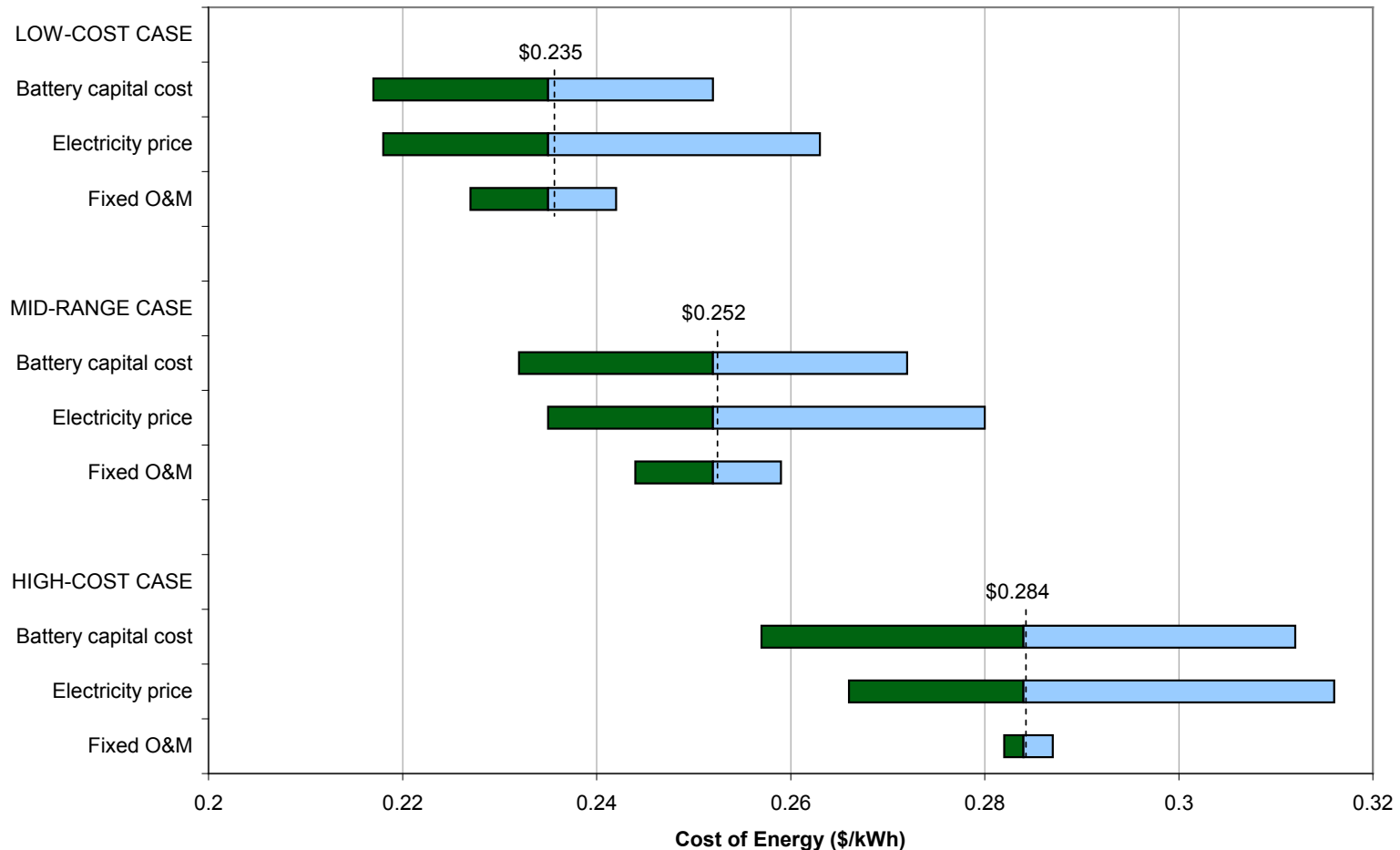

Sodium sulfur battery systems are more sensitive to electricity price than NiCd batteries.

# Net Present Cost of Vanadium Redox Batteries

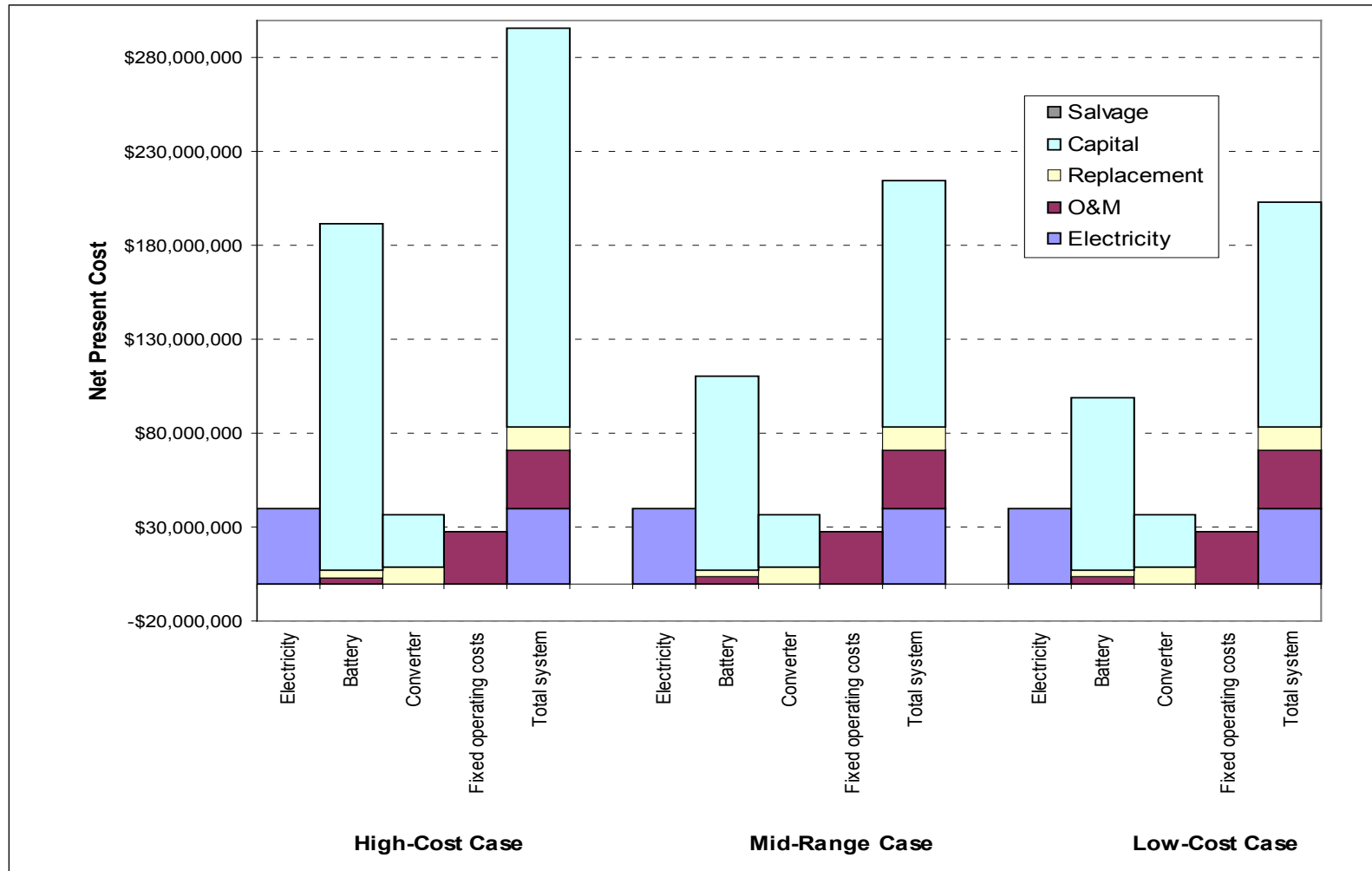

Electrolyte has a high initial capital cost but is assumed to last the entire lifespan of the facility.

# VR Batteries—Sensitivity

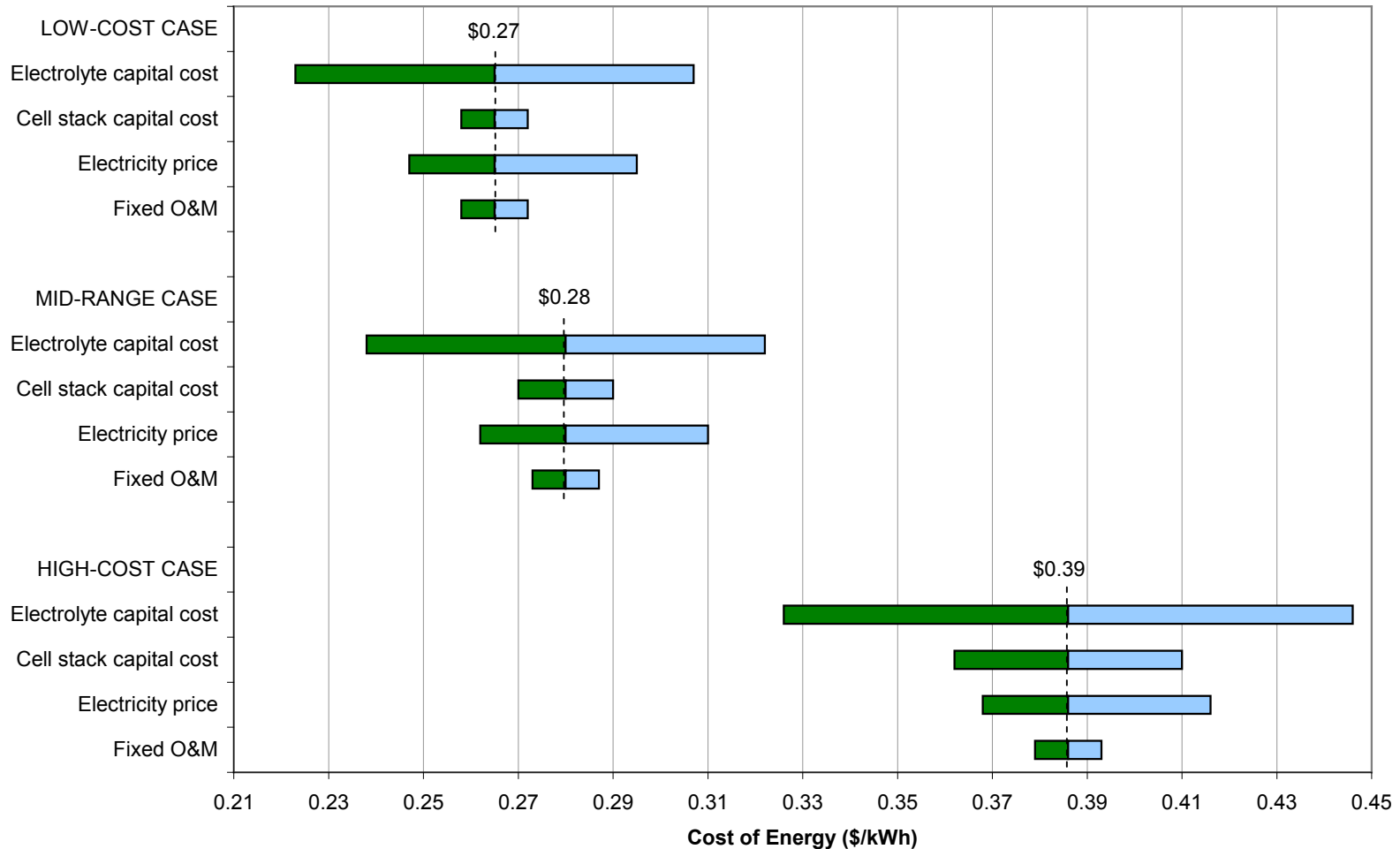

Electrolyte cost was varied  $\pm 50\%$  due to historical volatility in vanadium prices. VR battery LCOE is most sensitive to the cost of the electrolyte.

# Net Present Cost of Pumped Hydro

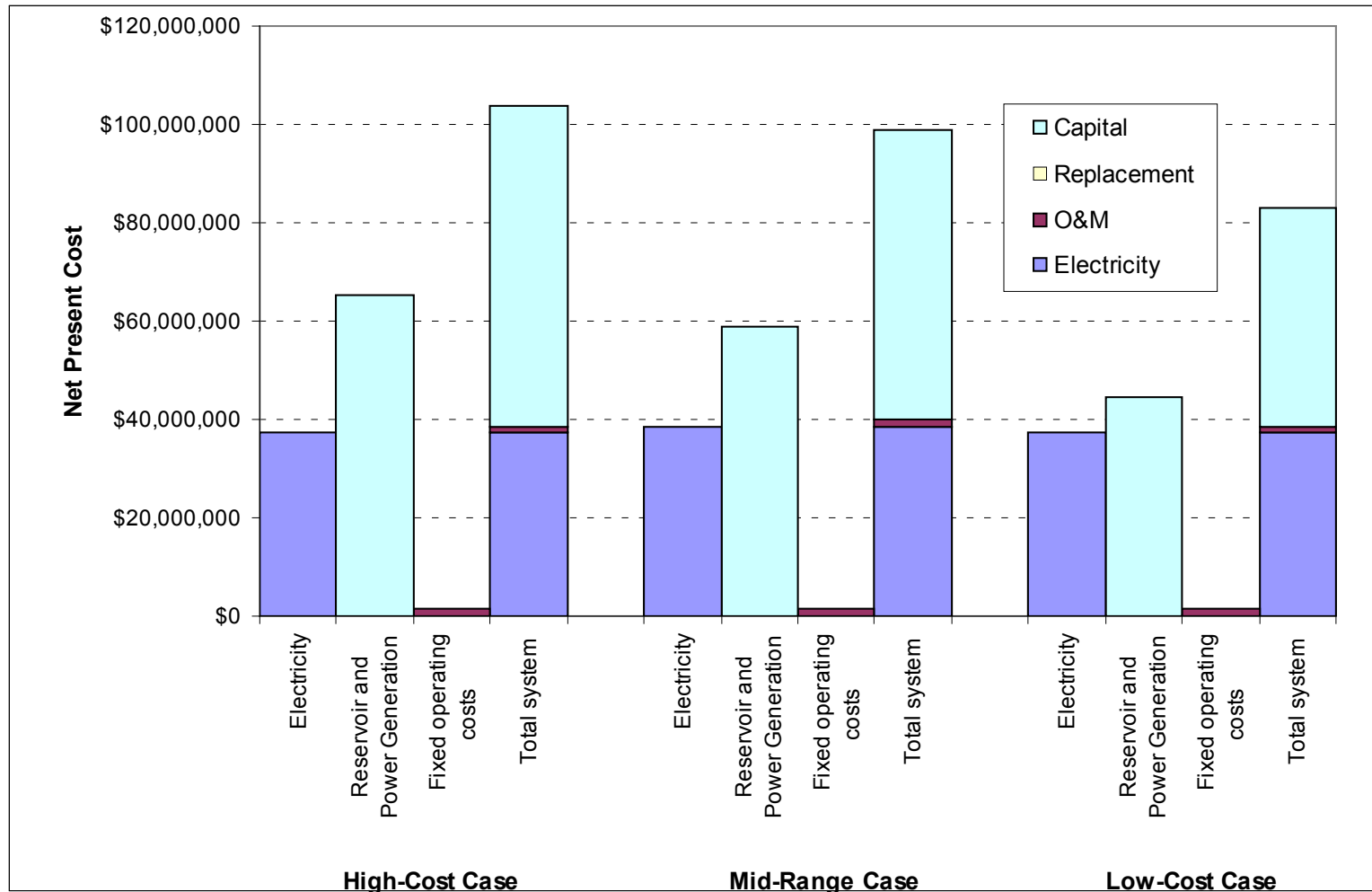

Pumped hydro systems have relatively low capital cost and very low maintenance costs in comparison to hydrogen and battery systems.



# Pumped Hydro—Sensitivity

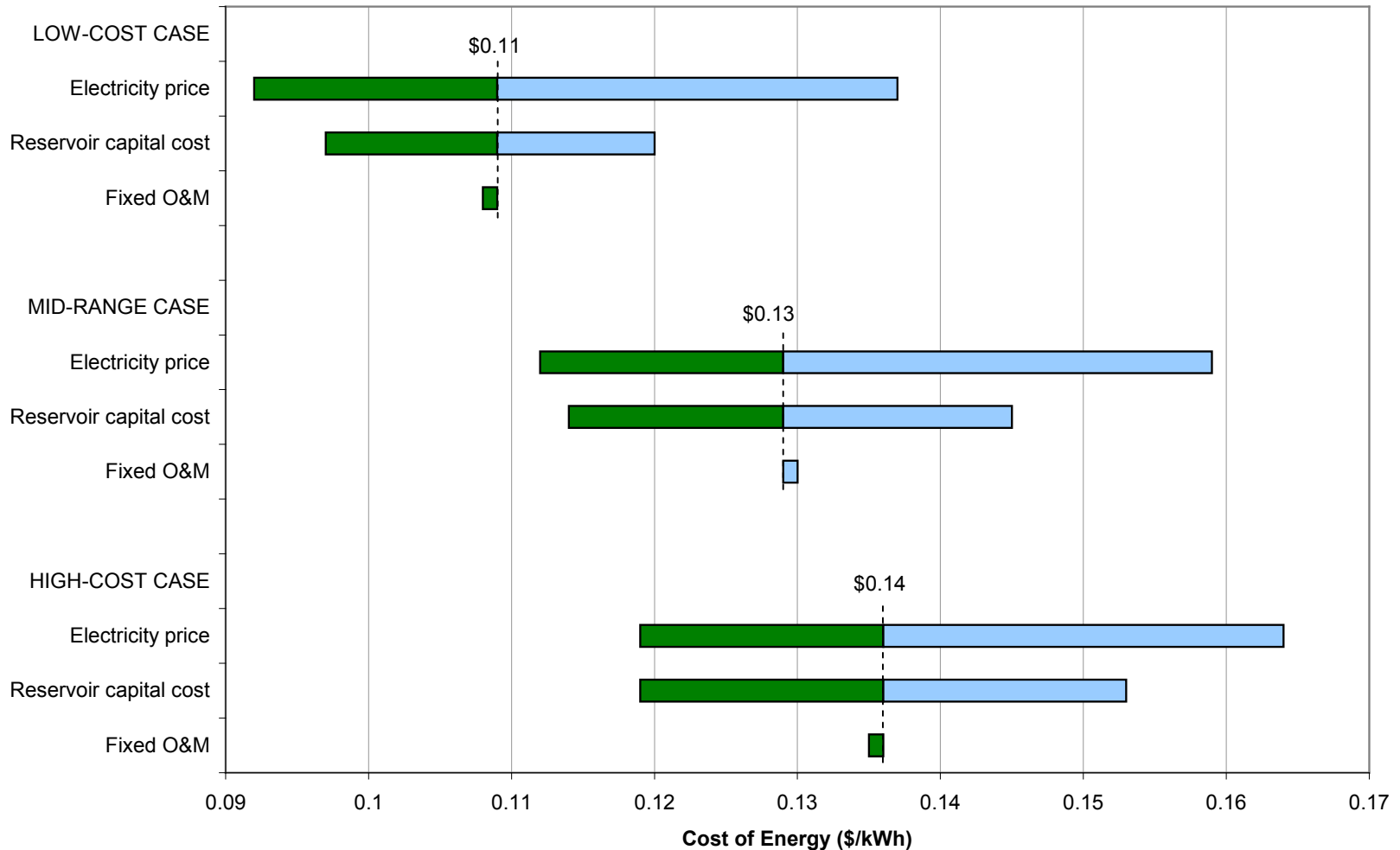

Pumped hydro systems are relatively sensitive to electricity price because electricity is a relatively large fraction of the overall yearly cost.

# Net Present Cost of Compressed Air Energy Storage

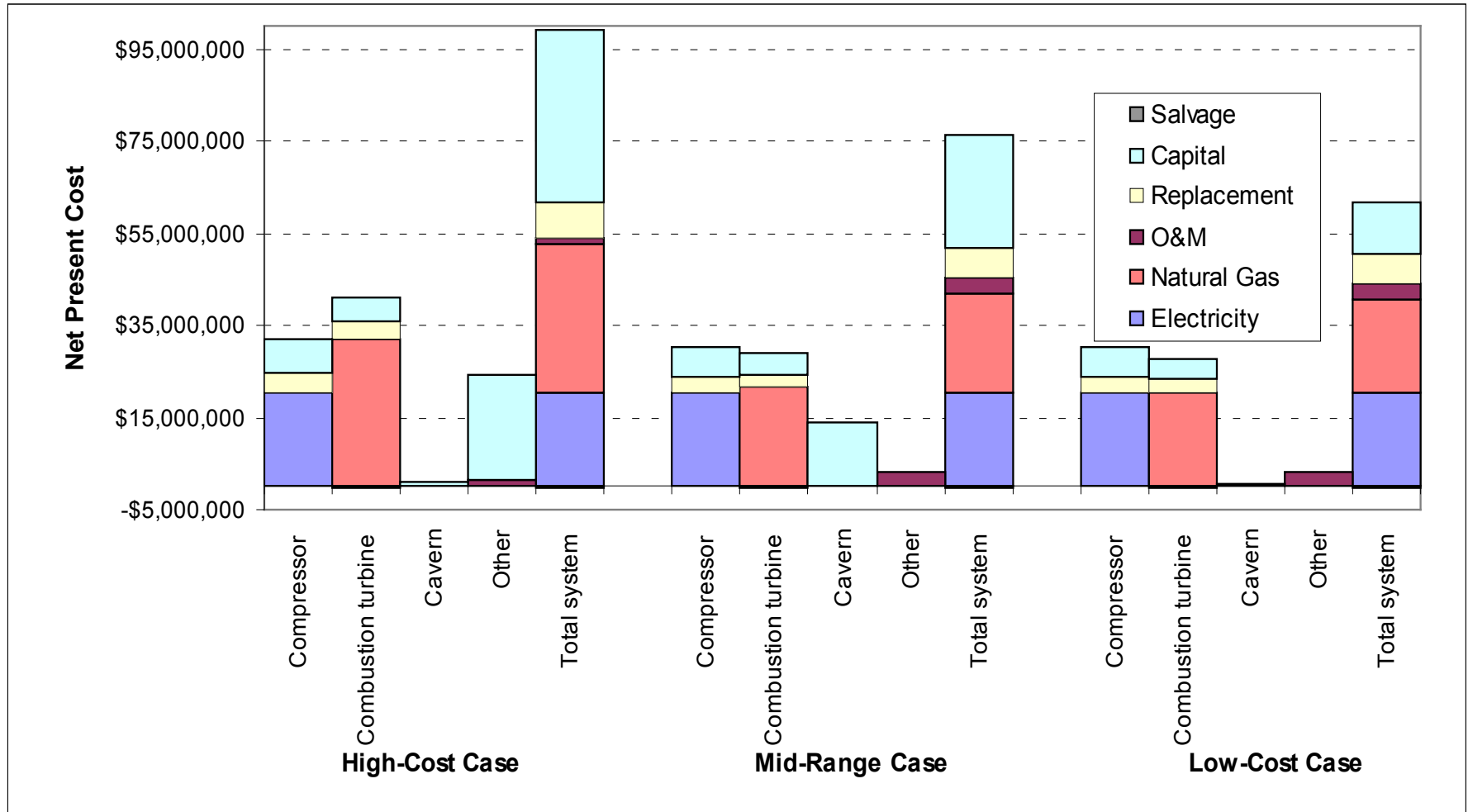

Approximately 1/3 of the output energy from the CAES systems is derived from natural gas. Approximately 2/3 of the energy is supplied by stored compressed air.

# CAES—Sensitivity

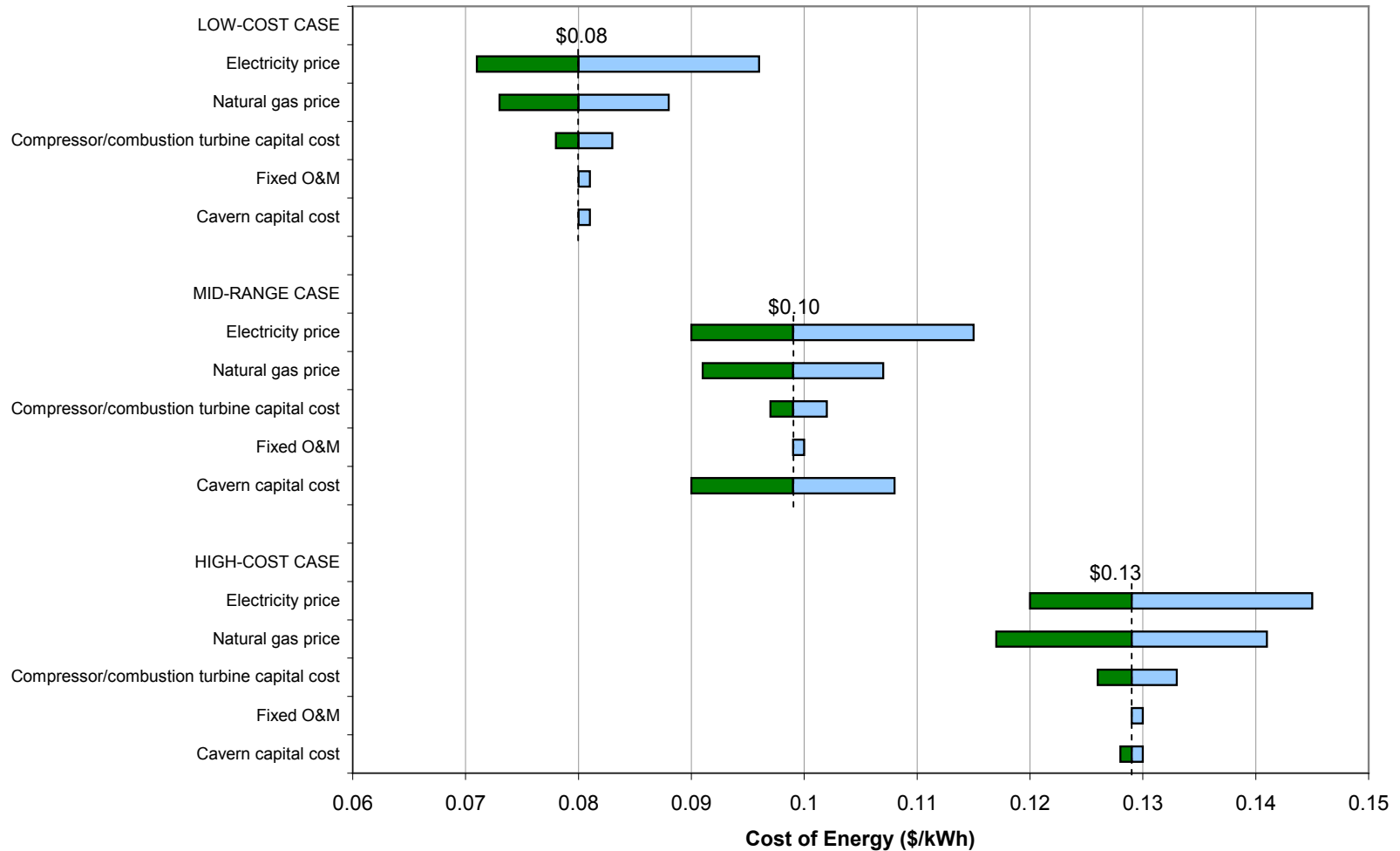

Assumed aboveground storage for the mid-range case to provide comparison to hydrogen system.

# Backup Slides—Hydrogen Systems

<b>System Component</b>	<b>High-Cost Case Values</b>	<b>Mid-Range Case Values</b>	<b>Low-Cost Case Values</b>
<b>Fuel cell system installed capital cost (\$2008)</b>	\$3,000/kW	\$813/kW	\$434/kW
<b>Stack replacement frequency/cost</b>	13 yr <sup>1</sup> /30% of initial capital cost	15 yr/30% of initial capital cost	26 yr <sup>1</sup> /30% of initial capital cost
<b>O&amp;M costs</b>	\$50/kW-yr <sup>2</sup>	\$27/kW-yr	\$20/kW-yr <sup>2</sup>
<b>Fuel cell life</b>	13 yr (20,000-hour operation)	15 yr (24,000-hour operation)	26 yr (40,000-hour operation)
<b>Fuel cell system efficiency (LHV)</b>	47%	53% <sup>3</sup>	58% <sup>4</sup>

- DOE (2007), Chapter 3.4; 20,000 hours for stationary PEM reformate system fuel cells 5–250 kW has been demonstrated. The goal for 2011: “By 2011, develop a distributed generation PEM fuel cell system operating on natural gas or LPG that achieves 40% electrical efficiency and 40,000 hours durability at \$750/kW.” Validated by 2014. Twenty thousand hours (13 years) was used for the high-cost value, and 40,000 hours (26 years) was used for the low-cost value.
- Values are from Lipman et al. (2004).
- Current technology value for stack efficiency is approximately 55% (O’Hayre et al. 2006). Value is mid-way between the high and low estimates.
- Assumed stack efficiency of 60% (MYPP 2010 target for direct hydrogen fuel cells for transportation) with 2% conversion losses for integrated system.

# Backup Slides—Hydrogen Systems

## Hydrogen Fueled Gas Turbine—Cost values and projections based on literature review

Source	Year	Raw data	Converted \$2008/kW	Notes
Afgan and Carvalho (2004)	2004	750 €/kW	\$1,044	From Onanda.com historical data, using avg euro:usd for 2004 = 1.244; based on simple natural gas turbine plant
Phadke et al. (2008)	2008	\$758/kW	\$758	Compares several coal cycles, this is plant for CCGT
Siemens (2007)	2008	< \$,1000	\$1,000	"Power block (equipment + construction): 2 hydrogen-fueled GTs, 2 HRSGs, 1 steam turbine, 3 generators and all associated auxiliaries/controls/BOP equipment"
Pilavachi et al. (2009)	2008	680 €/kW	\$1,001	From Onanda.com historical data, using avg euro:usd for 2008 = 1.47; costs includes total power plant costs - equipment and installation

# Backup Slides—Batteries

Cost values primarily based on two Sandia reports (2003 and 2008) and three EPRI reports (2003, 2006, and 2007)

	Energy Capacity Related Cost (Battery) (\$/kWh)	Power Related Cost (PCS) (\$/kW)	BoP (\$/kWh)	Fixed O&M (\$/kW-y)
<b>Nickel Cadmium</b>				
High Case <sup>1</sup>	1,570	288 <sup>3</sup>	173	5.8
Mid-Range Case <sup>2</sup>	1,380	150 <sup>10</sup>	115 (\$/kW)	31
Low-Range Case <sup>4</sup>	690	144	173	5.8
<b>Sodium Sulfur</b>				
High Case <sup>5</sup>	288	173	58	23
Mid-Range Case <sup>6</sup>	226	235	115 (\$/kW)	59
Low-Range Case	30% reduction from mid-range case <sup>3</sup>	173	58	59
<b>Vanadium Redox<sup>9</sup></b>				
High Case <sup>7</sup>	300	1800	500 (\$/kW)	54.8
Mid-Range Case <sup>8</sup>	210	750	500 (\$/kW)	54.8
Low-Range Case <sup>8</sup>	210	30% reduction from mid- range case	500 (\$/kW)	54.8

# Backup Slides—Batteries

1. Schoenung and Hassenzahl (2003). Actual costs for Fairbanks Alaska facility.
2. EPRI-DOE (2003).
3. PCS cost is derived from equation in EPRI-DOE (2003) for a programmed response PCS without VAR support;  $\$/kW (\$2003) = 11,500 * V_{min}^{-0.59}$  where  $V_{min}$  is the minimum discharge voltage (maximum current).
4. Schoenung and Eyer (2008).
5. Schoenung and Hassenzahl (2003), Schoenung and Eyer (2008). Replacement costs at \$230/kWh.
6. Values from EPRI-DOE (2003), NKG Insulators Ltd, E50 peak shaving battery (50-kW modules).
7. Electrolyte costs are not expected to decrease in the future due to the cost of vanadium. Electrolyte makes up about 30% of the capital cost of the system. However, future improvements in the system are expected to result in some cost reduction. Electrolyte costs decrease from \$256/kWh to \$151/kWh for the future case.
8. EPRI (2007) “present day” costs. Replacement cost for cell stack only at “future” cost.
9. EPRI (2007) “future” costs. Replacement cost for cell stack only at “future” cost.

# Backup Slides—Pumped Hydro and CAES

## Pumped Hydro System Costs

	Storage System Including PCS	BoP (\$/kWh)	Fixed O&M (\$/kW-y)
<b>High-cost case</b>	\$12/kWh + \$1,209/kW	5	2.9
<b>Mid-range case</b>	\$12/kWh + \$1,151/kW	5	2.9
<b>Low-cost case</b>	\$12/kWh + \$888/kW	0	2.9

Cost values based on literature review and existing installations

- Schoenung and Hassenzahl (2003)
- Capacity and Cost Information for 1,000-MW and Larger Pumped Hydro Installations Worldwide (Electricity Storage Association 2009)

## CAES System Costs

	Storage System Including PCS	BoP (\$/kWh)	Fixed O&M (\$/kW-y)	Natural Gas Heat Rate (Btu/kWh)
<b>High-cost case</b>	\$3.45/kWh + \$490/kW	58	2.9	6,000
<b>Mid-range cost case</b>	\$34.54/kWh + \$403/kW	0	6.9	4,000
<b>Low-cost case</b>	\$1.15/kWh + \$403/kW	0	6.9	3,800

- Schoenung and Eyer (2008)
- Nakhamkin (2007)
- van der Linden (2006)
- EPRI-DOE (2004)
- Schoenung and Hassenzahl (2003)
- EPRI-DOE (2003)
- EPRI (2003)



# Backup Slides—Efficiency

<b>System (Mid-Range Case @ \$0.038/kWh)</b>	<b>Roundtrip Efficiency (%)</b>
Fuel cell/aboveground storage	34 (LHV)
Fuel cell/geologic storage	35 (LHV)
Hydrogen expansion/combustion turbine	48 (LHV)
CAES <sup>1</sup>	53
Nickel cadmium battery	59
Sodium sulfur battery	77
Vanadium redox battery	72
Pumped hydro	75

1. AC-to-AC roundtrip efficiency for the CAES system is defined as the total electricity output divided by the total energy input (electricity plus natural gas).

# Analysis Matrix

	Peak Electricity	Spinning Reserve	Base Load	System Size	Compare to: (Management Strategy)	Compare to: (Storage Method)
Hydrogen for Base Loading	X		X	Large	<ul style="list-style-type: none"> <li>○ Curtail wind</li> <li>○ Turn down base capacity</li> <li>○ Buy electricity</li> </ul>	Pumped hydro CAES
Hydrogen for Base Loading (Rev. FC)	X		X	Large	<ul style="list-style-type: none"> <li>○ Curtail wind</li> <li>○ Turn down base capacity</li> <li>○ Buy electricity</li> </ul>	Pumped hydro CAES
Hydrogen for Vehicles		X	X	Medium	<ul style="list-style-type: none"> <li>○ Curtail wind</li> <li>○ Turn down base capacity</li> </ul>	Batteries
Hydrogen for Vehicles (Rev. FC)		X	X	Medium	<ul style="list-style-type: none"> <li>○ Curtail wind</li> <li>○ Turn down base capacity</li> </ul>	Batteries

# Backup Slides—Geologic storage

**Table 1. Costs of Geologic Storage Cavern Development for CAES and Hydrogen**

Formation Type	Air \$/kWh (\$2003)	Air \$/kWh (\$2008)	Air \$/m <sup>3</sup> (\$2008)	Hydrogen \$/kWh <sup>1</sup>
Solution-mined salt caverns <sup>2</sup>	1.00	1.20	2.88	0.02
Dry-mined salt caverns <sup>2</sup>	10.00	11.50	27.60	0.16
Rock caverns created by excavating comparatively impervious rock formations <sup>2</sup>	30.00	35.00	84.00	0.49
Naturally occurring porous rock formations (e.g., sandstone and fissured limestone) from depleted gas or oilfields <sup>2</sup>	0.10	0.12	0.29	0.002
Abandoned limestone or coal mines <sup>2</sup>	10.00	11.50	27.60	0.16
Geologic storage of hydrogen <sup>3</sup>	N/A	N/A	N/A	0.30

<sup>1</sup>Hydrogen storage cavern development cost is calculated assuming the same \$/m<sup>3</sup> as for CAES cavern development and energy density from Crotogino and Huebner (2008).

<sup>2</sup>Source: EPRI (2003) and Crotogino and Huebner (2008).

<sup>3</sup>Equation from H2A Delivery Scenario Analysis Model Version 2.02, for 41,000-kg usable storage capacity, [www.hydrogen.energy.gov/h2a\\_delivery.html](http://www.hydrogen.energy.gov/h2a_delivery.html).

# Backup Slides—Geologic Storage in Salt Deposits (Source: Casey 2009)



Figure 2 - Known Salt Deposits in the United States  
(after Anon., 1980B).

# Backup Slides—Geologic Storage in Depleted Oil and Gas Fields (Source: Born and Lord 2008)

**Oil and Gas Fields in the United States**



Source: Mast et al., 2008

# Backup Slides—Geologic Storage in Sedimentary Basins (Source: Born and Lord 2008)

**Sedimentary Basins in the United States**

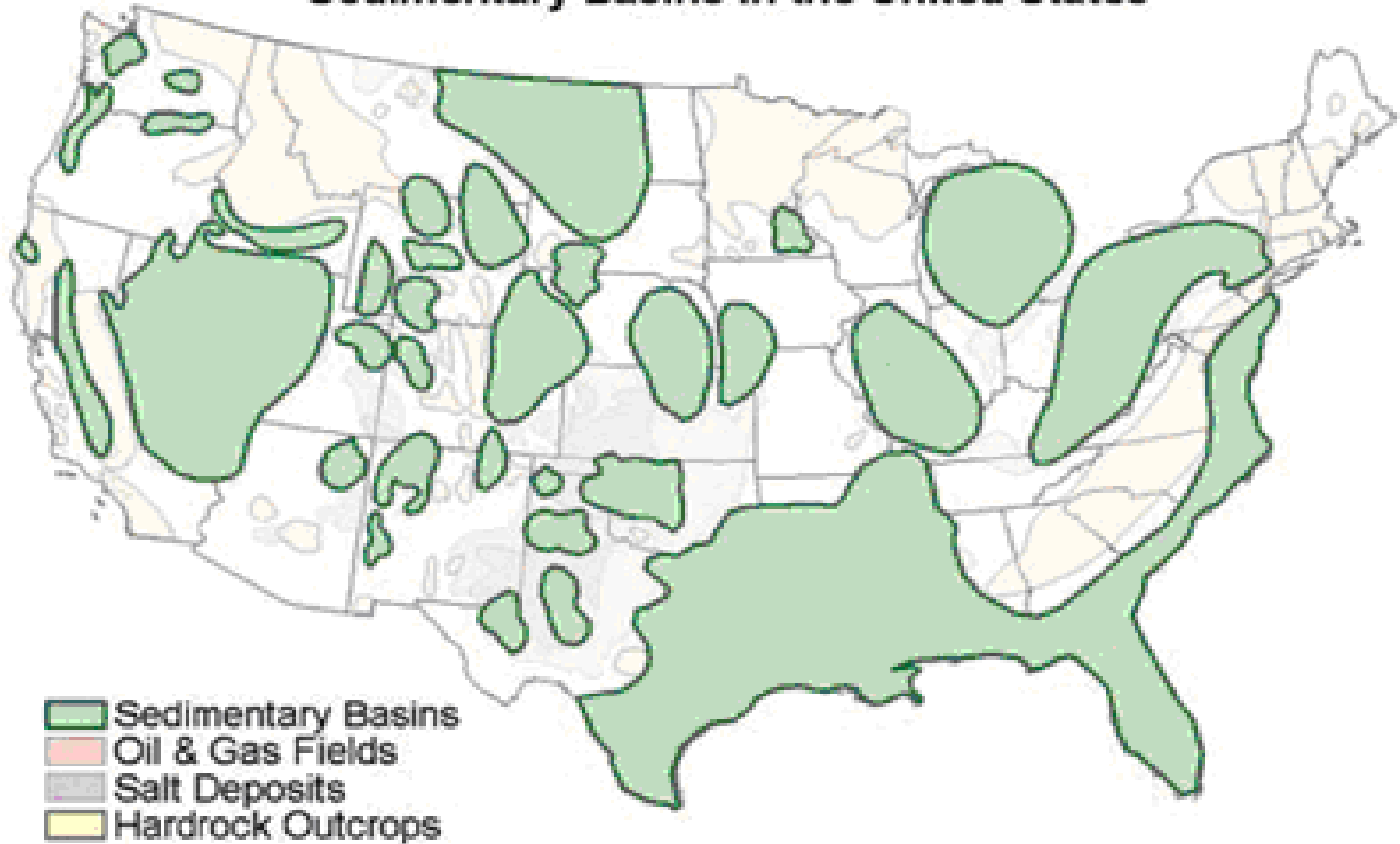

Source: Folt et al., 1979

# References for PEM Fuel Cell Chart

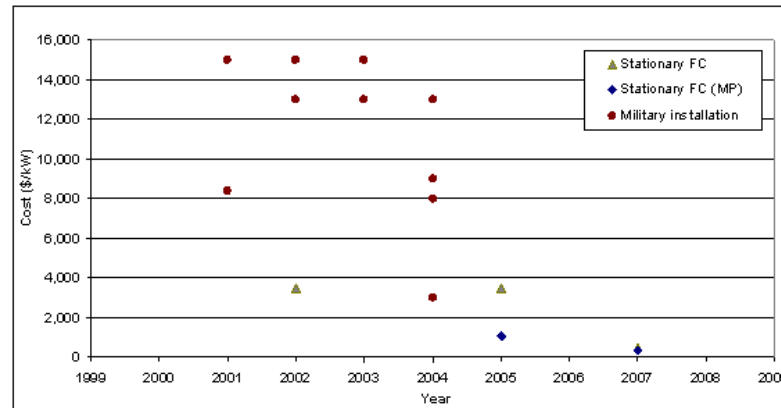

Dhathathreyan, K.S.; Rajalakshmi, N. (2007). "Polymer Electrolyte Membrane Fuel Cell." S. Basu, ed. Recent Trends in Fuel Cell Science and Technology. New York: Springer, pp. 40–115.

Stone, H.J. (2005). Economic Analysis of Stationary PEM Fuel Cell Systems. Columbus, OH: Battelle Memorial Institute.

Lipman, T.E.; Edwards, J.L.; Kammen, D.M. (2004). "Fuel Cell System Economics: Comparing the Costs of Generating Power with Stationary and Motor Vehicle PEM Fuel Cell Systems." Energy Policy, vol. 32(1), pp. 101–125.

# Vanadium Prices 1997 – 2005

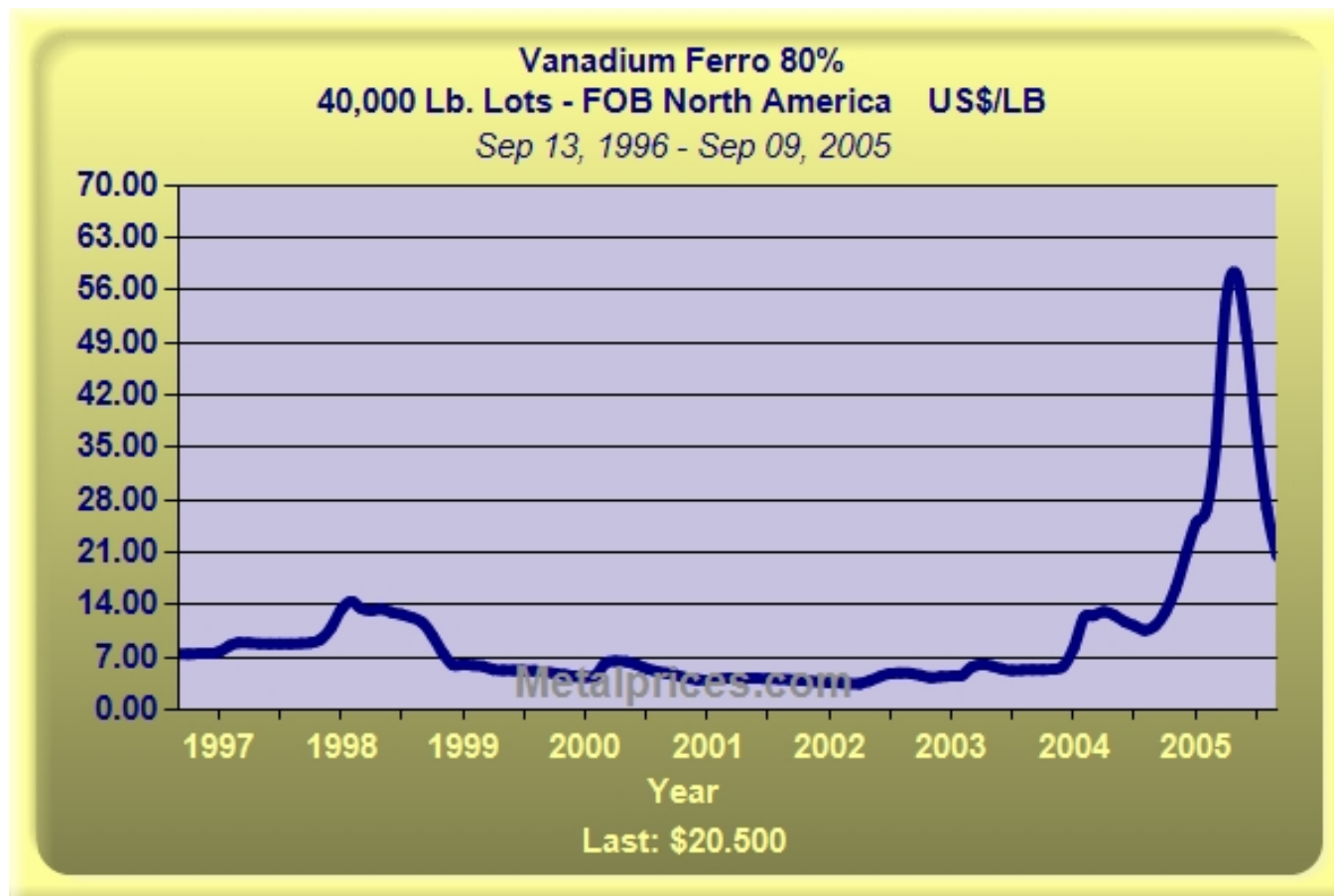

Source: [http://www.metalprices.com/FreeSite/Charts/v\\_ferro\\_charts.html?weight=lb#Chart5](http://www.metalprices.com/FreeSite/Charts/v_ferro_charts.html?weight=lb#Chart5)

The cost of delivered energy from the vanadium redox battery systems is most sensitive to the price of the electrolyte.



# Schematic for Alabama McIntosh 110-MW CAES Plant

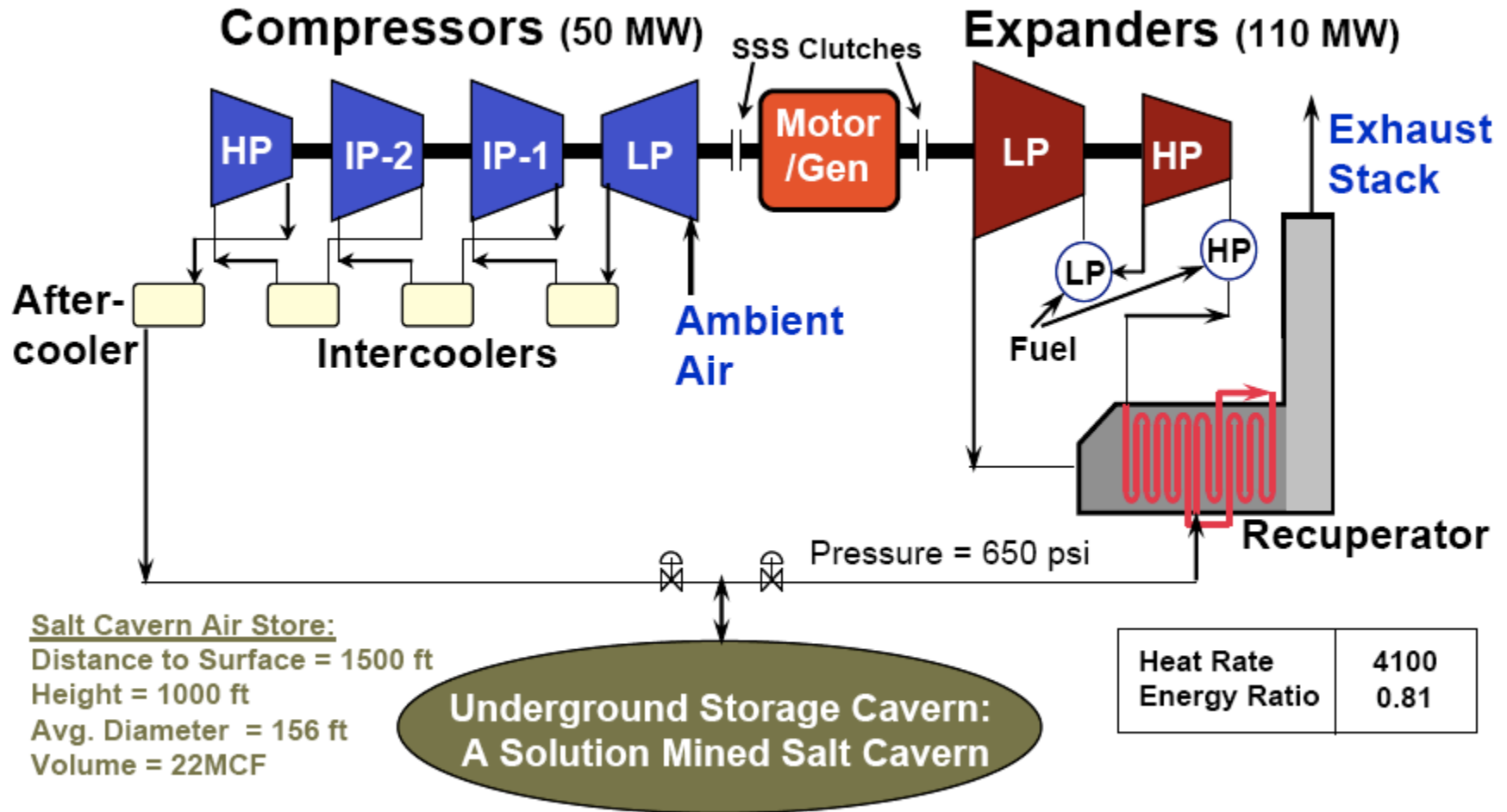

Source: Nakhamkin, M., and M. Chiruvolu, *Available Compressed Air Energy Storage (CAES) Concepts*.

# Study References

- Afgan, N.H.; Carvalho, M.G. (2004). "Sustainability Assessment of Hydrogen Energy Systems." *International Journal of Hydrogen Energy*, 29(13), pp. 1327–1342.
- Argonne National Laboratory (2009). Hydrogen Delivery Components model v1.1. [www.hydrogen.energy.gov/h2a\\_delivery.html](http://www.hydrogen.energy.gov/h2a_delivery.html), accessed 2009.
- Argonne National Laboratory (2009a). Hydrogen Delivery Scenario Analysis model v2.02. [www.hydrogen.energy.gov/h2a\\_delivery.html](http://www.hydrogen.energy.gov/h2a_delivery.html), accessed 2009.
- Borns, D.J.; Lord, A.S. (2008). "Geologic Storage of Hydrogen." DOE Hydrogen Program FY 2008 Annual Progress Report. Washington, DC: U.S. Department of Energy.
- Casey, E. (2009). "Salt Dome Hydrogen Storage." Fuel Pathways Integration Technical Team (FPITT) Meeting, Washington, DC, March 7, 2009.
- Crotogino, F.; Huebner, S. (2008). "Energy Storage in Salt Caverns: Developments and Concrete Projects for Adiabatic Compressed Air and for Hydrogen Storage." Solution Mining Research Institute Spring 2008 Technical Conference, Porto, Portugal, April 28–29, 2008.
- Denholm, P.; Margolis, R. (2006) "Very Large-Scale Deployment of Grid-Connected Solar Photovoltaics in the United States: Challenges and Opportunities." Preprint to be presented at Solar 2006 Denver, Colorado, July 8–13, 2006.
- Denholm, P.; Kulcinski, G.L. (2004). "Life Cycle Energy Requirements and Greenhouse Gas Emissions from Large Scale Energy Storage Systems." *Energy Conversion and Management*, 45, pp. 2153–2172.
- Dennis, R.A. (2008a). "Hydrogen Combustion in Near Zero Emissions IGCC: DOE Advanced Turbine Program." ASME/IGTI Turbo Expo 2008, Berlin, Germany, June 9–13, 2008.
- Dennis, R.A. (2008b). "Hydrogen Turbines for Coal-Based IGCC: DOE Advanced Turbine Program." ASME/IGTI Turbo Expo 2008, Berlin, Germany, June 9–13, 2008.
- Dhathathreyan, K.S.; Rajalakshmi, N. (2007). "Polymer Electrolyte Membrane Fuel Cell." S. Basu, ed. *Recent Trends in Fuel Cell Science and Technology*. New York: Springer, pp. 40–115.
- DOE (2007). Multi-year Research, Development and Demonstration Plan (MYPP). Washington, DC: U.S. Department of Energy. [www.eere.energy.gov/hydrogenandfuelcells/mypp/index.html](http://www.eere.energy.gov/hydrogenandfuelcells/mypp/index.html).

# Study References

- DOE (2009). Fuel Cells Technologies Program Web site: Types of Fuel Cells, Polymer Electrolyte Membrane Fuel Cells. [www.eere.energy.gov/hydrogenandfuelcells/fuelcells/fc\\_types.html#pem](http://www.eere.energy.gov/hydrogenandfuelcells/fuelcells/fc_types.html#pem), accessed September 2009.
- DOE-FE (2005). "10 New Projects to Help Enable Future Turbines for Hydrogen Fuels." Fossil Energy Techline, September 8, 2005. [www.fossil.energy.gov/news/techlines/2005/tl\\_enabling\\_turbines\\_awards.html](http://www.fossil.energy.gov/news/techlines/2005/tl_enabling_turbines_awards.html). Washington, DC: U.S. Department of Energy Fossil Energy Office.
- Electricity Storage Association (2009). Pumped Hydro Web page. [www.electricitystorage.org/site/technologies/pumped\\_hydro](http://www.electricitystorage.org/site/technologies/pumped_hydro), accessed 2009.
- EPRI (2003). Comparison of Storage Technologies for Distributed Resource Applications. Palo Alto, CA: Electric Power Research Institute.
- EPRI (2006). Technology Review and Assessment of Distributed Energy Resources: Distributed Energy Storage. Palo Alto, CA: Electric Power Research Institute.
- EPRI (2007). Vanadium Redox Flow Batteries: An In-Depth Analysis. Palo Alto, CA: Electric Power Research Institute.
- EPRI-DOE (2003). EPRI-DOE Handbook of Energy Storage for Transmission and Distribution Applications. Palo Alto, CA: Electric Power Research Institute; Washington, DC: U.S. Department of Energy.
- EPRI-DOE (2004). EPRI-DOE Handbook Supplement of Energy Storage for Grid-Connected Wind Generation Applications. Palo Alto, CA: Electric Power Research Institute; Washington, DC: U.S. Department of Energy.
- Gleick, P.H. (1994). "Water and Energy." Annual Review of Energy and Environment, vol. 19, pp. 267–299.
- Greenblatt, J.B.; Succar, S.; Denkenberger, D.C.; Williams, R.H. (2004). "Toward Optimization of a Wind/Compressed Air Energy Storage (CAES) Power System." Electric Power Conference, Baltimore, MD, March 30–April 1, 2004.
- IKA (2009). Large Hydrogen Underground Storage. Aachen, Germany: RWTH Aachen University, Institut für Kraftfahrzeuge. [www.ika.rwth-aachen.de/index-e.php](http://www.ika.rwth-aachen.de/index-e.php).
- Juste, G.L. (2006). "Hydrogen Injection as Additional Fuel in Gas Turbine Combustor: Evaluation of Effects." International Journal of Hydrogen Energy, 31, pp. 2112–2121.
- Lambert, T.; Gilman, P.; Lilienthal, P. (2006) "Micropower System Modeling with HOMER." In Integration of Alternative Sources of Energy, by F. Farret and M. Simões. New York: Wiley. <http://homerenergy.com/documentation.asp>.

# Benchmarking—Other Benefits and Drawbacks of Hydrogen Energy Storage Relative to Alternatives

System Operation	
Benefits	Drawbacks
Modular (can size the electrolyzer separately from FC to produce extra hydrogen)	Low electrolysis/FC round trip (AC to AC) efficiency (50–55%) Even lower round-trip efficiency when hydrogen is used in a combustion turbine (<40%)
Very high energy density for compressed hydrogen (>100 times the energy density for compressed air at 120 bar $\Delta P$ , CC GT)	Hydrogen storage in geologic formations other than salt caverns may not be feasible
System can be fully discharged at all current levels	Electrolyzers and fuel cells require cooling
Cost	
Benefits	Drawbacks
Research has potential to drive down costs	Use of precious metal catalysts for low-temperature fuel cells
	Currently high cost relative to competing technologies (>\$1,000/kW)

Source: Crotagino and Huebner, *Energy Storage in Salt Caverns / Developments and Concrete Projects for Adiabatic Compressed Air and for Hydrogen Storage*, SMRI Spring 2008 Technical Conference, Portugal, April 2008.

# Benefits and Drawbacks of Hydrogen Energy Storage

Environmental	
Benefits	Drawbacks
Catalyst can be reclaimed at end of life	Environmental impacts of mining and manufacturing of catalyst
	Low round-trip efficiency increases emissions for conventional electricity and reduces replacement by renewables

Source: Denholm, Paul, and Gerald L. Kulcinski, *Life cycle energy requirements and greenhouse gas emissions from large scale energy storage systems*, Energy Conversion and Management, 45 (2004) 2153-2172.

# Benefits and Drawbacks of Battery Energy Storage

System Operation	
Benefits	Drawbacks
Modular	Battery voltage to current relationship limits the amount of energy that can be extracted, especially at high current
Mid range to high round trip efficiency (65%–75%)	
Cost	
Benefits	Drawbacks
Sodium sulfur and Vanadium Redox battery system cost	Nickel cadmium battery system cost
High round-trip efficiency reduces arbitrage scenario costs	
Environmental	
Benefits	Drawbacks
	Toxic and hazardous materials

Source: EPRI-DOE Handbook of Energy Storage for Transmission and Distribution Applications, 2003, EPRI, Palo Alto, CA and the U.S. Department of Energy, Washington, DC.

# Benefits and Drawbacks of Pumped Hydro Energy Storage

System Operation	
Benefits	Drawbacks
Well established and simple technology	System requires large reservoir of water (or suitable location for reservoir)
High round-trip efficiency (70%–80%)	System requires mountainous terrain
	Extremely low energy density (0.7 kWh/m <sup>3</sup> )
Cost	
Benefits	Drawbacks
Inexpensive to build and operate	
Environmental	
Benefits	Drawbacks
No toxic or hazardous materials	Large water losses due to evaporation, especially in dry climates
	Habitat loss due to reservoir flooding
	Stream flow and fish migration disruption

Source: Denholm, Paul, and Gerald L. Kulcinski, *Life cycle energy requirements and greenhouse gas emissions from large scale energy storage systems*, Energy Conversion and Management, 45 (2004) 2153-2172.

# Benefits and Drawbacks of Compressed Air Energy Storage

System Operation	
Benefits	Drawbacks
Proposed advanced designs store heat from compression giving theoretical efficiency of 70%—comparable to pumped hydro	Low round-trip efficiency (54%) with waste heat from combustion used to heat expanding air—42% without
	Very low storage energy density (2.4 kWh/m <sup>3</sup> )
	Must be located near suitable geologic caverns
Cost	
Benefits	Drawbacks
Low cost	
Environmental	
Benefits	Drawbacks
	Approximately 1/3 of output energy is derived from natural gas feed to combustion turbines resulting in additional GHG emissions

Source: Crotogino and Huebner, *Energy Storage in Salt Caverns / Developments and Concrete Projects for Adiabatic Compressed Air and for Hydrogen Storage*, SMRI Spring 2008 Technical Conference, Portugal, April 2008.